

Sheyenne Tooling & Mfg.

Sheyenne Sunmaster

**High Capacity
Corn,
Milo
&
Sunflower
Attachment**

Operator's Manual



Sheyenne Tooling & Manufacturing
701 Lenham Ave. SW/PO Box 647
Cooperstown ND 58425
800-797-1883 or 701-797-2700
Fax 701-797-2584

www.sheynnemfg.com

Table of Contents

Topic	Page No.
Table of Contents	2
Serial Number Location	3
Sunmaster Warranty	4 – 6
Introduction	7
Safety	8 – 12
Safety Sign off Form	13
Features	14
Operation	15
Gathering Chains	15 – 16
Importance of Proper Speed of Gathering Chains	17
Sprocket and PTO Requirements (also see pp 41 - 45)	18
Left Side of Machine	19
Right Side of Machine & Ridge Bar	20
Vibrating Gathering Pans	21 – 22
Access to Servicing, Cutting Head, Knives, Gearboxes, Tension	23
Gearboxes	24 – 26
Gearbox Clutches	27 – 29
Rotary Cutting Knives	30
Drum	31 – 33
Row Dividers	34 – 35
Single Drive	36 – 37
Double Drive	38 – 40
Header Adapters, Feeder House	41
Telescoping PTO and Driveshaft	42
PTO Chart, 2013 and after	43
Driveshaft Numbers – Before & After Engineering Changes	44
PTO Chart, 2012 and before	45
Shipment of Units	46
Presetting from Factory	46
Lubrication and Maintenance	47 - 48
Index	49

Serial Number Location

Always give your dealer the serial number of your Sunmaster Header when ordering parts or requesting service or other information.

The Serial Number plate is located where indicated. Please mark the number in the space provided for easy reference.



Model # _____
Serial # _____
Production Year _____

Please enter information below and **SAVE FOR FUTURE REFERENCE**

SUNMASTER HEADER WARRANTY

SHEYENNE TOOLING & MANUFACTURING warrants each new product to be free from defects in material and workmanship. This warranty is applicable only for the normal service life expectancy of the machine or components, not to exceed **twelve consecutive months** from the date of delivery of the new SHEYENNE TOOLING & MANUFACTURING product to the original purchaser.

Genuine SHEYENNE TOOLING & MANUFACTURING replacement parts and components will be warranted for 90 days from date of purchase, or the remainder of the original equipment warranty period, whichever is longer.

Under no circumstances will it cover any merchandise or components thereof, which in the opinion of the company, has been subject to negligent handling, misuse, alteration, an accident, or if repairs have been made with parts other than those obtainable through SHEYENNE TOOLING & MANUFACTURING.

Our obligation under this warranty shall be limited to repairing or replacing, free of charge to the original purchaser, any part that in our judgment shall show evidence of such defect, provided further that such part shall be returned within thirty (30) days from date of failure to SHEYENNE TOOLING & MANUFACTURING.

This warranty shall not be interpreted to render us liable for injury or damages of any kind or nature to person or property.

Except as set forth above, **SHEYENNE TOOLING & MANUFACTURING shall have no obligation of liability of any kind on account of any of its equipment and shall not be liable for special or consequential damage. SHEYENNE TOOLING & MANUFACTURING makes no other warranty, express or implied, and, specifically, SHEYENNE TOOLING & MANUFACTURING disclaims any implied warranty of merchantability of fitness for a particular purpose. Some states or provinces do not permit limitations or exclusions of implied warranties of incidental or consequential damages, so the limitations or exclusions in this warranty may not apply.**

This warranty is subject to any existing conditions of supply, which may directly affect our ability to obtain materials or manufacture replacement parts.

SHEYENNE TOOLING & MANUFACTURING reserves the right to make improvements in design or changes in specifications at any time, without incurring any obligations to owners of units previously sold.

No one is authorized to alter, modify or enlarge neither this warranty nor the exclusions, limitations and reservations.

I have read and understand the above instructions and warranty. **Warranty is invalid until all three copies are completed and signed. Customer copy retained, dealer copy in dealer's possession and manufacturer's copy returned.**

Date Purchased _____

Dealership _____

Model Number _____

Serial Number _____

Customer Signature _____

Date _____

Dealer Signature _____

Date _____

Customer Copy

(Keep in this book)

Please enter information below and **SAVE FOR FUTURE REFERENCE**

SUNMASTER HEADER WARRANTY

SHEYENNE TOOLING & MANUFACTURING warrants each new product to be free from defects in material and workmanship. This warranty is applicable only for the normal service life expectancy of the machine or components, not to exceed **twelve consecutive months** from the date of delivery of the new SHEYENNE TOOLING & MANUFACTURING product to the original purchaser.

Genuine SHEYENNE TOOLING & MANUFACTURING replacement parts and components will be warranted for 90 days from date of purchase, or the remainder of the original equipment warranty period, whichever is longer.

Under no circumstances will it cover any merchandise or components thereof, which in the opinion of the company, has been subject to negligent handling, misuse, alteration, an accident, or if repairs have been made with parts other than those obtainable through SHEYENNE TOOLING & MANUFACTURING.

Our obligation under this warranty shall be limited to repairing or replacing, free of charge to the original purchaser, any part that in our judgment shall show evidence of such defect, provided further that such part shall be returned within thirty (30) days from date of failure to SHEYENNE TOOLING & MANUFACTURING.

This warranty shall not be interpreted to render us liable for injury or damages of any kind or nature to person or property.

Except as set forth above, **SHEYENNE TOOLING & MANUFACTURING shall have no obligation of liability of any kind on account of any of its equipment and shall not be liable for special or consequential damage. SHEYENNE TOOLING & MANUFACTURING makes no other warranty, express or implied, and, specifically, SHEYENNE TOOLING & MANUFACTURING disclaims any implied warranty of merchantability of fitness for a particular purpose. Some states or provinces do not permit limitations or exclusions of implied warranties of incidental or consequential damages, so the limitations or exclusions in this warranty may not apply.**

This warranty is subject to any existing conditions of supply, which may directly affect our ability to obtain materials or manufacture replacement parts.

SHEYENNE TOOLING & MANUFACTURING reserves the right to make improvements in design or changes in specifications at any time, without incurring any obligations to owners of units previously sold.

No one is authorized to alter, modify or enlarge neither this warranty nor the exclusions, limitations and reservations.

I have read and understand the above instructions and warranty. **Warranty is invalid until all three copies are completed and signed. Customer copy retained, dealer copy in dealer's possession and manufacturer's copy returned.**

Date Purchased _____

Dealership _____

Model Number _____

Serial Number _____

Customer Signature _____

Date _____

Dealer Signature _____

Date _____

Dealer Copy



PLEASE ENTER INFORMATION BELOW AND RETURN TO SHEYENNE TOOLING AND MANUFACTURING

SUNMASTER HEADER WARRANTY

SHEYENNE TOOLING & MANUFACTURING warrants each new product to be free from defects in material and workmanship. This warranty is applicable only for the normal service life expectancy of the machine or components, not to exceed twelve consecutive months from the date of delivery of the new SHEYENNE TOOLING & MANUFACTURING product to the original purchaser.

Genuine SHEYENNE TOOLING & MANUFACTURING replacement parts and components will be warranted for 90 days from date of purchase, or the remainder of the original equipment warranty period, whichever is longer. Warranty is not applicable for normal wear and usage.

Under no circumstances will it cover any merchandise or components thereof, which in the opinion of the company, has been subject to negligent handling, misuse, alteration, an accident, or if repairs have been made with parts other than those obtainable through SHEYENNE TOOLING & MANUFACTURING.

Our obligation under this warranty shall be limited to repairing or replacing, free of charge to the original purchaser, any part that in our judgement shall show evidence of such defect, provided further that such part shall be returned within thirty (30) days from date of failure to SHEYENNE TOOLING & MANUFACTURING.

This warranty shall not be interpreted to render us liable for injury or damages of any kind or nature to person or property.

Except as set forth above, SHEYENNE TOOLING & MANUFACTURING shall have no obligation of liability of any kind on account of any of its equipment and shall not be liable for special or consequential damage. SHEYENNE TOOLING & MANUFACTURING makes no other warranty, express or implied, and, specifically, SHEYENNE TOOLING & MANUFACTURING disclaims any implied warranty of merchantability of fitness for a particular purpose. Some states or provinces do not permit limitations or exclusions of implied warranties of incidental or consequential damages, so the limitations or exclusions in this warranty may not apply.

This warranty is subject to any existing conditions of supply, which may directly affect our ability to obtain materials or manufacture replacement parts.

SHEYENNE TOOLING & MANUFACTURING reserves the right to make improvements in design or changes in specifications at any time, without incurring any obligations to owners of units previously sold.

No one is authorized to alter, modify or enlarge neither this warranty nor the exclusions, limitations and reservations.

I have read and understand the above instructions and warranty. I have also read the owner's manual and understand all safety precautions. **Warranty is invalid until all three copies are completed and signed. Customer copy retained, dealer copy in the dealer's possession and the manufacturer's copy returned.**

Date Purchased _____ Dealership _____
 Model Number _____ Serial Number _____
 Customer Information: Name (Please Print) _____
 Address _____
 City _____, State _____, Zip Code _____
 E-Mail (If Applicable) _____
 Signature _____, Date _____

Dealer Signature _____ Date _____

Please return via; fax, regular mail or e-mail; to:
fax number – (701) 797-2584
address --
Sheyenne Tooling and Manufacturing
PO Box 647
Cooperstown, ND 58425
e-mail – warranty@sheyennemfg.com



INTRODUCTION

Congratulations on your choice of the Sunmaster Harvest Header for your farming operation. This machine has been manufactured for a safe, efficient and trouble free operation. Safe operation of the machine requires that the operator reads and completely understands the information in this operators manual.

Keep this manual handy for frequent reference and to pass on to new operators or owners. Call your Sheyenne dealer if you need assistance, information or additional copies of this manual.

Operator orientation: the directions left, right and rear as mentioned throughout the manual are seen from the driver's seat.

Safety

YOU are responsible for the safe operation and maintenance of your Sunmaster. **YOU** must ensure that you and anyone else who is going to operate, maintain or work around the Sunmaster is familiar with the operating and maintenance procedures and related safety information contained in this manual.

Remember, YOU are the key to safety. Good safety practices not only protect you, but also the people around you. Make these practices a working part of your safety program. Be certain that EVERYONE operating this equipment is familiar with the recommended operating and maintenance procedures and follows all the safety precautions. Most accidents can be prevented. Do not risk injury or death by ignoring good safety practices.

Sunmaster header owners must give operating instructions to operators or employees before allowing them to operate the Sunmaster and at least annually thereafter per OSHA (Occupational Safety and Health Administration) regulation 1928.57.

The most important safety device on this equipment is a safe operator. It is the operator's responsibility to read and understand all safety and operating instructions in the manual and to follow them. All accidents can be avoided.

A person who has not read and understood all operating and safety instructions is not qualified to operate the machine. An untrained operator exposes himself/herself and bystanders to possible serious injury or death.

Do not modify the equipment in any way. Unauthorized modification may impair the function and/or safety and could affect the life of the equipment.

When the Sunmaster is detached, or when any repairs are performed underneath the machine, always fully lower the four foot (4') support stands and securely pin. In addition, it is a good idea to place additional blocks under the machine. If the unit is still attached to combine, always secure the cylinder safety stop in place underneath the feeder housing.

Do not operate machine when any safety guards or panels are removed.



Have a first-aid kit available for use should the need arise and know how to use it.

Do not allow children, spectators, or bystanders within hazard area of machine.

Stop the engine, place all controls in neutral, set park brake, remove ignition key and wait for all moving parts to stop before servicing, adjusting, repairing, or unplugging.

Review safety related items annually with all personnel who will be operating or maintaining the Sunmaster.

When driving to another field secure the cylinder safety stop in place underneath the feeder housing.

Before starting machine, operator must make sure that all other persons especially children are clear of machine.

Keep hands, feet, hair, and clothing away from all moving parts.

Think SAFETY! Work SAFELY!

Why Is Safety Important To Us?

3 Big Reasons:

Accidents can kill and disable!

Accidents cost money!

Accidents can be avoided!



Operator is required to review and study each safety decal on the machine.

The following safety decals and their part numbers are part of the machine.

Decals are located on the following areas of the machine.



Part Number 69-016-206

P/N 69-016-207 left side
69-016-208 right side

Photo 002

P/N's 69-016-209 thru
69-016-217 dependent
upon row quantity and
row spacing.



P/N 69-016-054

P/N 69-016-057

P/N 69-016-055

Serial No. Plate

Photo 003

Decals are located on the following areas of the machine.



Photo 004

Part Number 69-016-204,
located on both sides of the
machine.



Photo 005

Part Number 69-016-203,
quantity (2) on machines
with double drive.

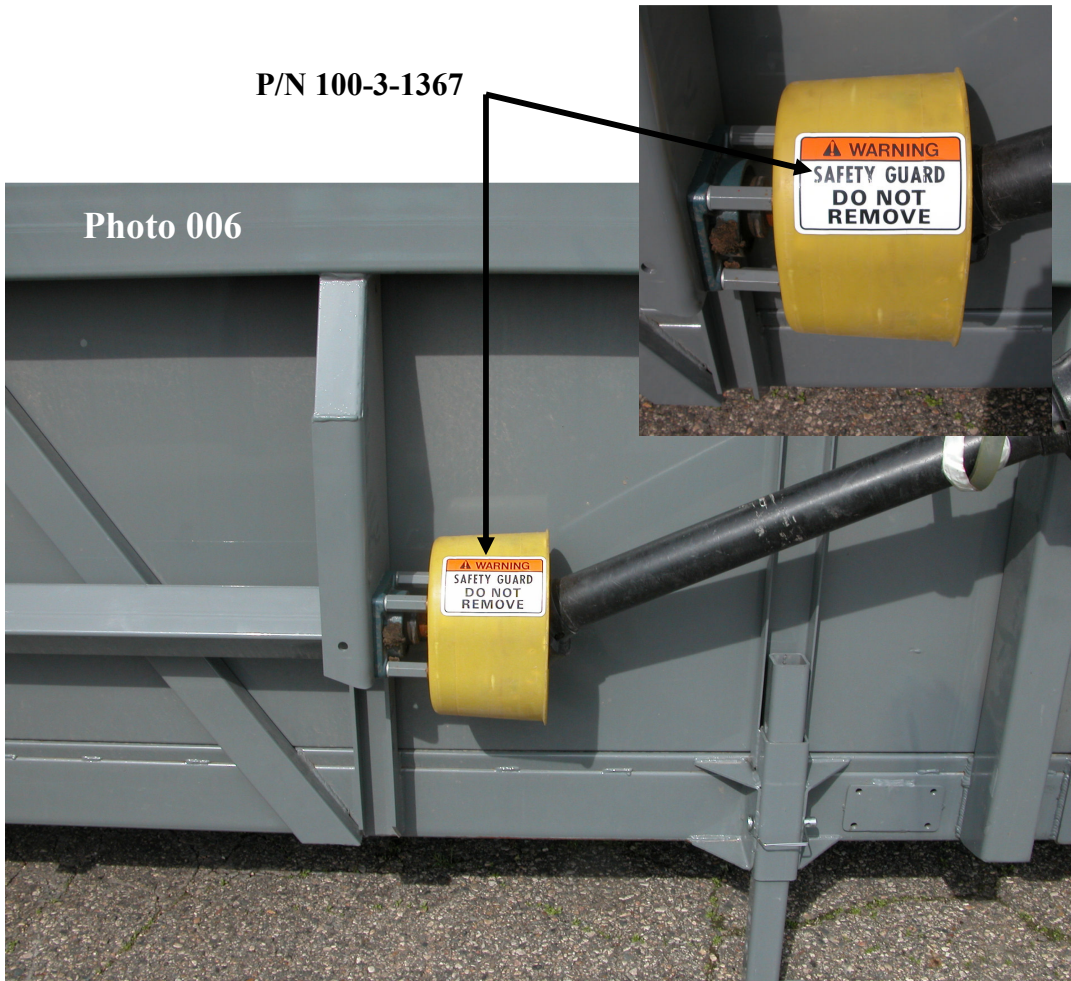

Sign-Off Form

Always follow the General Safety Standards specified by the American Society of Agricultural Engineers (ASAE) and the Occupational Safety and Health Administration (OSHA). Anyone who will be operating and/or maintaining the Sunmaster must read and clearly understand all safety, operating, and maintenance information presented in this manual.

Do not operate or allow anyone else to operate this equipment until such information has been reviewed. Annually review this information before the season start-up.

Make these periodic reviews of SAFETY and OPERATION a standard for all of your equipment. We feel that an untrained operator is unqualified to operate this machine.

A sign off sheet is provided for your record keeping to show that all personnel who will be working with the equipment have read and understand the information in the Operator's Manual and have been instructed in the operation of the equipment.

Sign-Off Form

DATE	EMPLOYEE'S SIGNATURE:	EMPLOYER'S SIGNATURE:

Features

The Sunmaster Harvester is the most successful row crop header in the world to harvest sunflowers that are lodged, broken over, or excessively dry. Its unique design will significantly minimize shattering and head losses so common with traditional harvesting equipment. Excellent for milo that is lodged because it can pick up the crop off the ground while cutting it off high enough to leave a taller standing stubble so desired for controlling erosion. Using the Sunmaster is an excellent choice for no-till corn because it eliminates much of the trash.

The rotary cutting knife is positioned at the back of the gathering chains and helps for more uniform feeding with less chance of the crop falling onto the ground or hanging up on the row dividers. The rotary cutting knife uses four larger and thicker heat treated sickle knives to ensure a clean cut.

With the aid of the gathering chains, the stalk moves towards the header platform. The top edge of the gathering pan and ridge bar help push the stalk to one side so that the head of the sunflower stalk drapes over the top of the next adjacent gathering pan. Any seeds that shatter are dropped onto the pan. A rocker arm underneath gently vibrates each gathering pan so that any seeds or dropped heads float to the platform header. When the sunflower head is cut off it drops nearly directly onto the header platform and is facing towards the feeder housing to ensure smooth feeding. This unique design significantly reduces crop losses, especially under extremely adverse conditions.

The extra length row dividers with its replaceable low height shoes will slide along on the ground with each row divider moving up and down independently allowing the operator to pick up any downed crop. Direction of travel with the Sunmaster will vary with field conditions. The Sunmaster may go against a lodged field or even cross-ways if the field is not too rough.

The Sunmaster is excellent for milo. Equipped with longer row dividers in front of the machine, the Sunmaster can go lower to the ground to pick up any downed crop while keeping the back of the header higher off of the ground. With the rotary cutting knife located farther back on the header, the Sunmaster is able to pick up any lodged crop and lift it to a taller height before it is cut off. The remaining stubble cut at a much taller height is desired by many growers to avoid erosion.

The Sunmaster is ideal for farmers who grow corn in rotation with sunflower or who raise no-till corn. The Sunmaster eliminates the trash for easier Spring planting and weed control.

Operation

Gathering Chains:

There is one gathering chain per row. The chain is #12 metric and is available at your Sunmaster dealer. Proper chain tightness is important and comes preset from the factory. Measure the spring on the gathering chain tightener with a tape measure to determine proper tightness. (See Photo 007) The measurement, as shown on the photo, should measure 3 ½". Tightener bolt is located on underside of gathering chain.

Another way of checking chain tightness is to pull one of the paddles of the gathering chain with your fingers (about 4 lbs. of pull). The paddle should move no farther than 3/8". (See Photo 007)

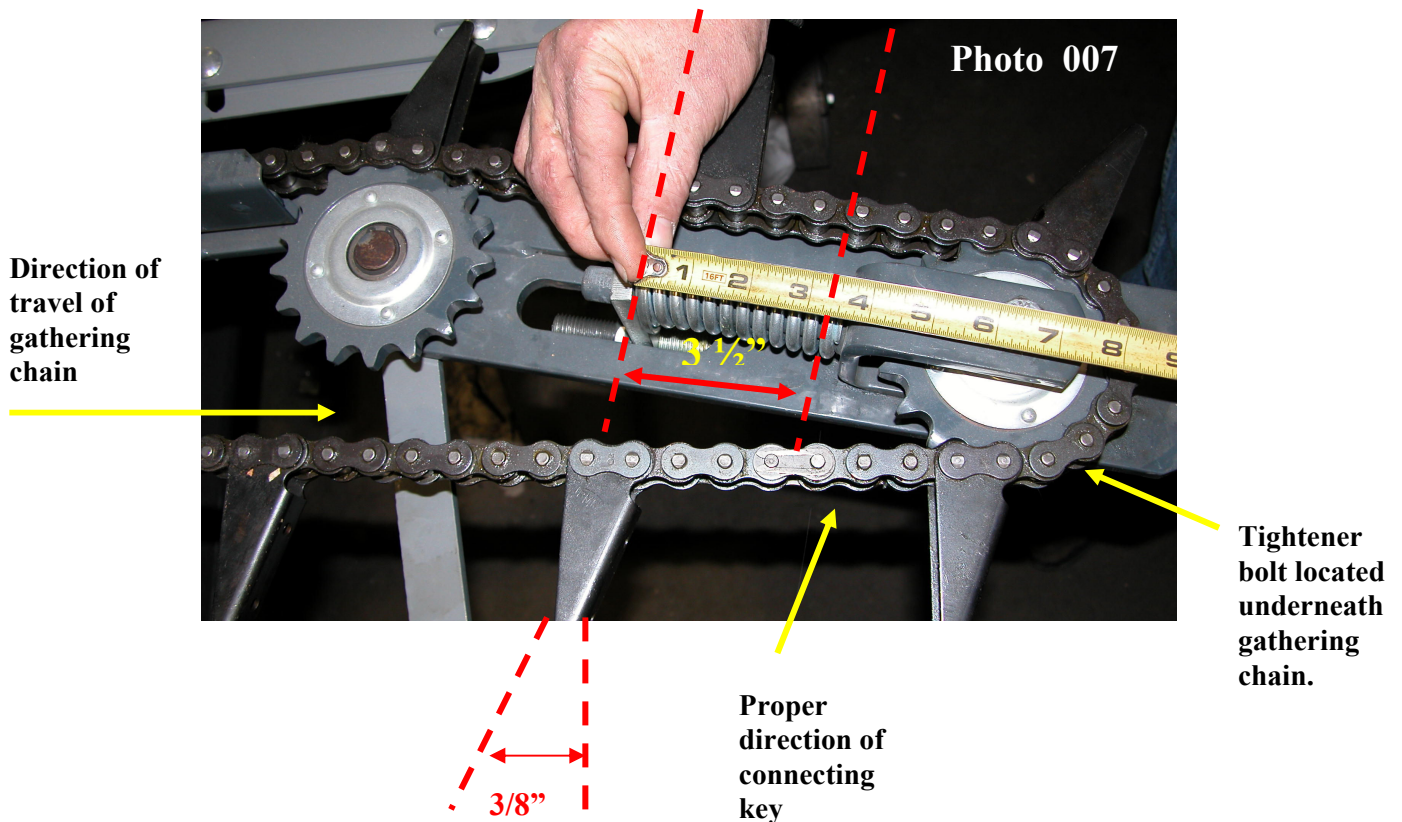

Do not oil or put grease on the gathering chain. Any oil or grease applied to the gathering chain may get into the slip clutch of the rotary cutting knife assembly and cause damage.

When installing or removing the gathering chain, for any reason, make sure the connecting link is installed in the right direction. (See Photo 007)

The recommended vertical distance between the paddle of the gathering chain and the ridge bar is $\frac{1}{4}$ ". (See Photo 008)

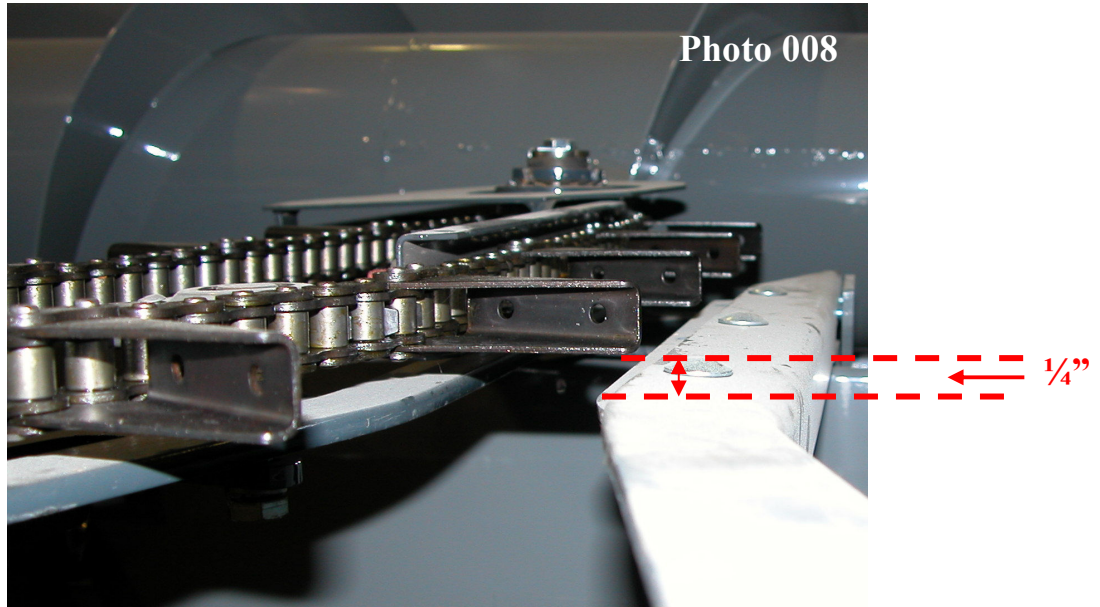

To adjust gathering chain height loosen bolt and slide bar up or down as needed and retighten bolt. (See Photo 009)

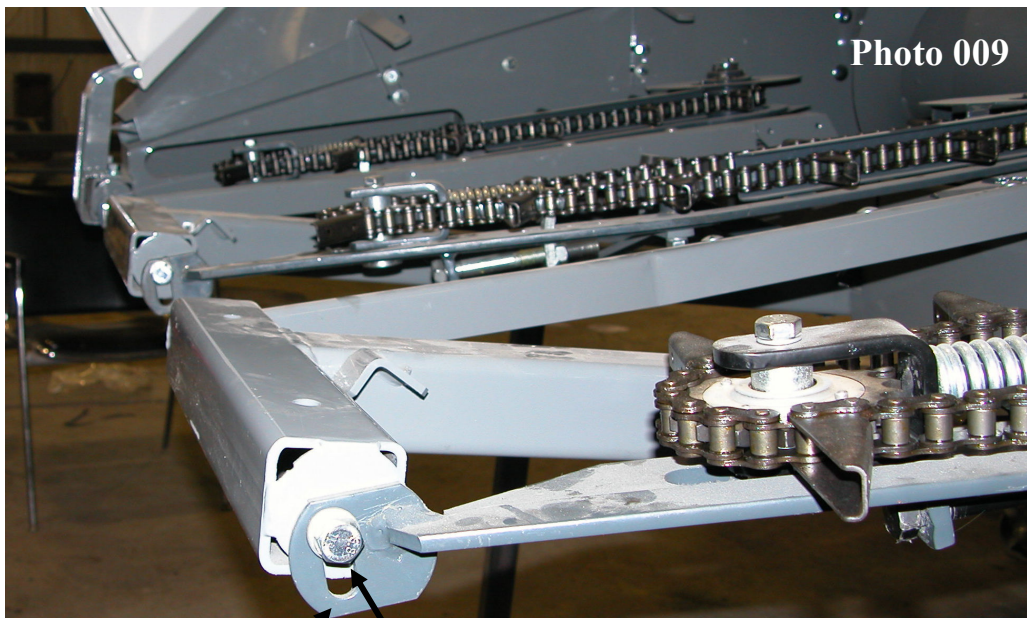

Slide up or
down as
needed

Loosen Bolt

Importance of proper speed of gathering chain

It is very important that the speed of the gathering chains match the ground speed of the machine. If not properly matched the gathering chain may go too fast and will try and pull the crop out of the ground rather than cutting it off, which puts more stress on the whole drive system. As crop begins to catch and accumulate around the rotary cutting knife, its clutch will begin to slip. With constant slipping the clutch plates may begin to glaze and need replacing. Burnishing the clutch plates may not be an option. If operator is in doubt as to correct chain speed, it is better to error on the side of having the gathering chain go slower than the ground speed.

However, if the gathering chain is running much slower than the ground speed of the machine, the stalk will be pushed forward. The rotary cutting knife begins to tear off the stalk rather than cut it cleanly putting additional wear on the cutting knives while leaving some crop in the field.

Proper speed of the gathering chain is not a problem with variable speed headers. For those combines without variable speed, there are different sized sprockets that can be changed to find the correct speed of gathering chains.

Sunmaster units are stocked at your dealer or delivered from the factory installed with the proper sized sprockets depending on combine model. Before ordering a Sunmaster from your dealer, please specify combine model so that the proper sized sprockets can be installed before delivery. New Sunmaster units also include three (3) additional sprockets of choice. Inquire at your dealer for choice of additional sprockets.

See Table 1 for recommended sprockets to use for proper speed of gathering chains. Numbers in table refer to the number of teeth on each sprocket. These sprockets are all double chain. The table assumes average crop and ground speed.

SPROCKET AND PTO REQUIREMENTS FOR SUNMASTER ADAPTERS

ADAPTER	DRIVE SPROCKET (DRIVER)	GEARBOX SPROCKET (DRIVEN)	EXTRA SPROCKETS	PTO LENGTH 8 ROW-30 INCH 12 ROW-20 INCH 12 ROW- 22 INCH	PTO LENGTH, ALL OTHER	PTO END
John Deere – 60 Series *	15	15 X 2	(13 & 16) X 2	26 Inches	48 Inches	1000
Case/IH – 2388	13	15 X 2	(13 & 16) x 2	34 Inches	48 Inches	Hex
Case - 8010	13	15 X 2	(13 & 16) x 2	26 Inches	48 Inches	540
Cat – Lexion	10	15 X 2	(13 & 16) x 2	26 Inches	48 Inches	1000
Cat – Challenger	12	15 X 2	(13 & 16) x 2	26 Inches	48 Inches	1000
Massey Ferguson	12	15 X 2	(13 & 16) x 2	26 Inches	48 Inches	1000
Gleaner	12	15 X 2	(13 & 16) x 2	26 Inches	48 Inches	1000
New Holland	18	18 X 2	(20 & 16) x 2	34 Inches	48 Inches	540

* John Deere has two feeder house widths
 'Standard' feeder houses are wider
 'Conventional' feeder houses are narrower

New Holland - CR & CX need 1/4 inch cut off the yoke end

Number of sprocket teeth	Double sprocket, Part Number**
10	24-005-829
11	24-009-241
12	24-009-243
13	24-005-817
14	24-005-827
15	24-005-828
16	24-005-826
18	24-005-825
20	24-005-923
22	24-009-242

Note: See pages 26 & 27 in the 20" parts book and pages 20 & 21 in the 30" parts book for other parts and part numbers in the drive assembly.
 See pages 42 – 45a in this manual for additional information on PTO components, current part numbers and history.

Photo 010 shows position of driven sprocket and drive sprocket on left side of machine. Photo also shows storage for additional sprockets, clutch tightening tool for rotary knife assembly, chain tightener, drum clutch, etc.

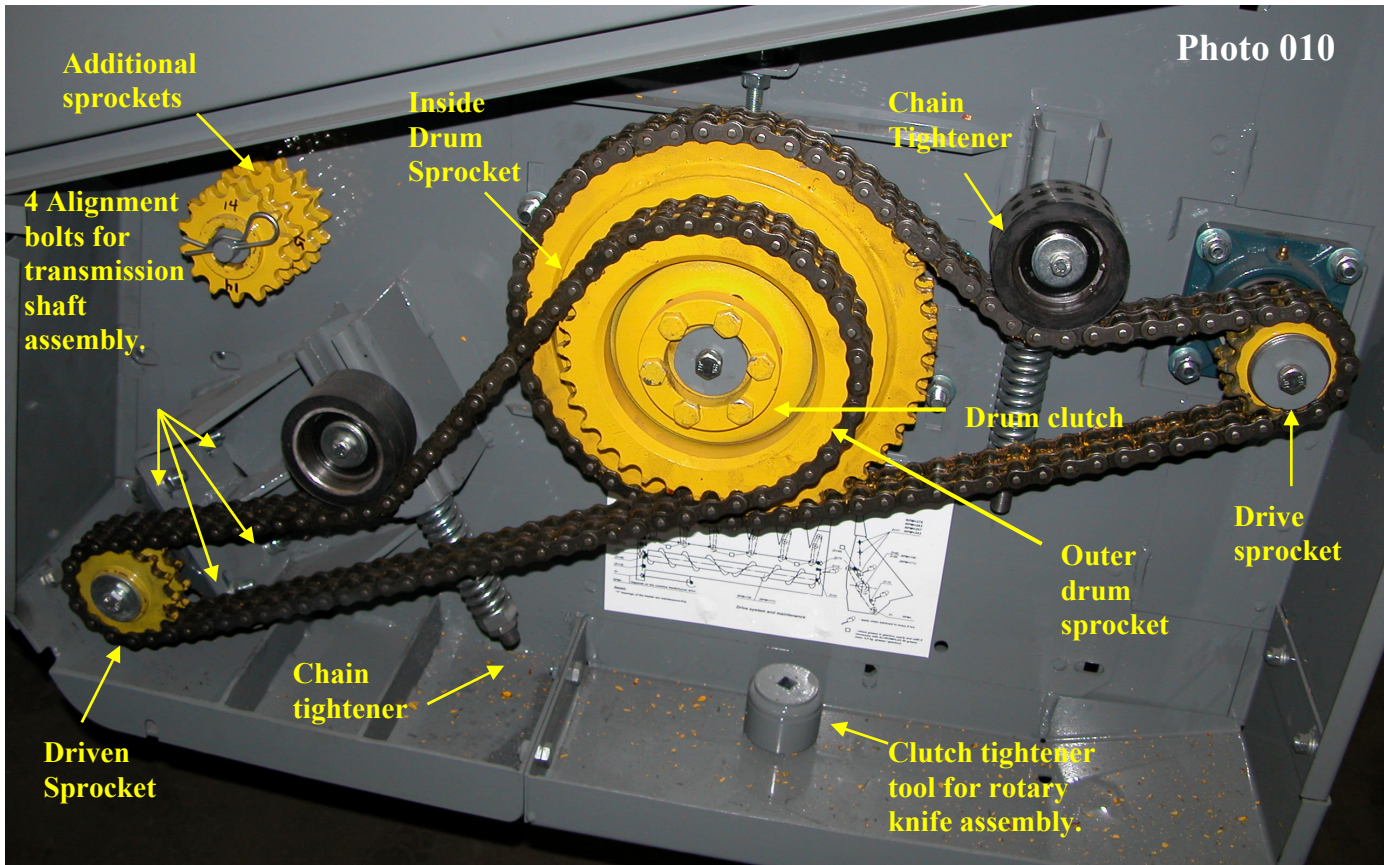

Left Side of Machine

Helpful Hints:

With crop coming over top of drum at the feeder—try smaller drive sprocket to slow down the drum. If gathering chains are going too fast try slowing them down by installing a larger driven sprocket. With a light crop stand the gathering chains may need to be speeded up—install smaller driven sprocket. With variable speed headers there should be no need to change the sprockets.

When changing the driven sprocket on the left side of the machine remember to change the driven sprocket on the right side of the machine. (See Photo 0011)

The drum sprockets are never changed and are the same size regardless of combine model. Inside drum sprocket is 48 teeth and outer drum sprocket is 33 teeth for either the 8 or 12 row or single or double drive machines.

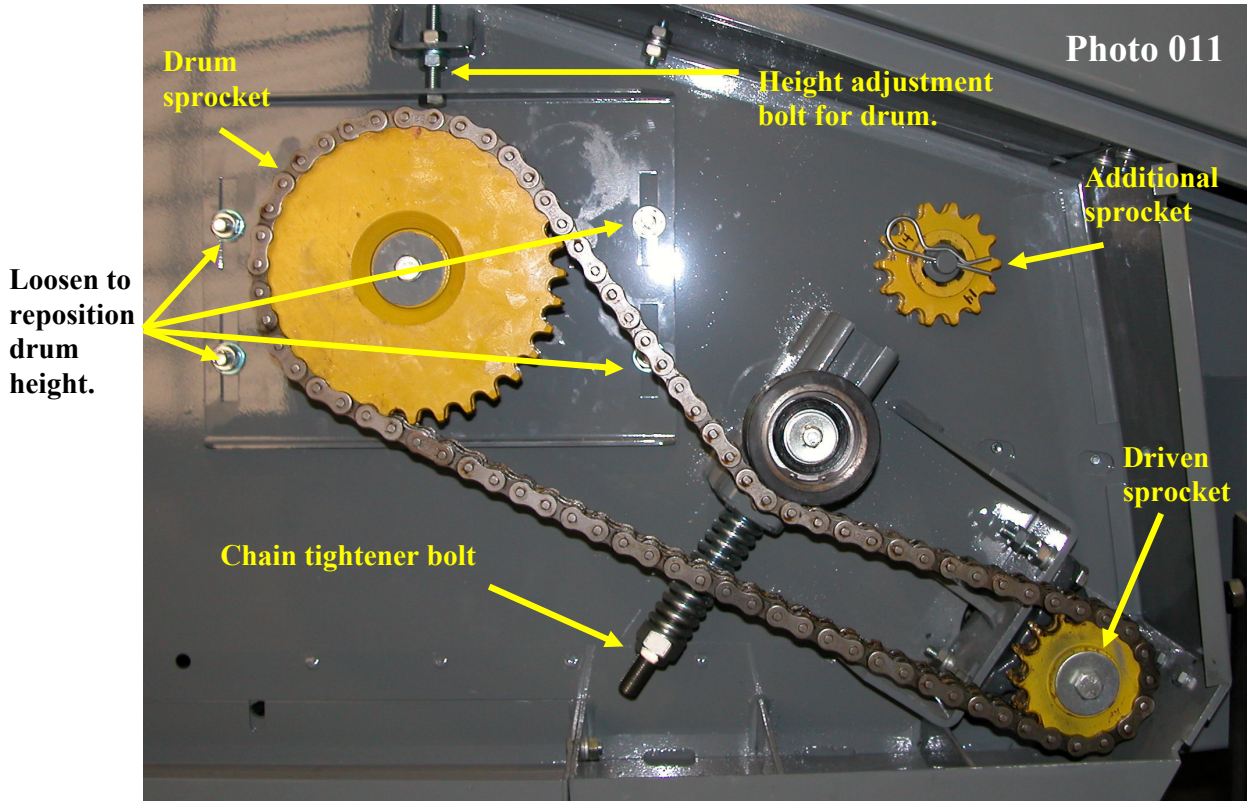

Right side of machine

To change sprockets simply loosen chain tightener, remove chain, remove and install sprocket, replace chain and retighten.

Ridge Bar

The purpose of the ridge bar is to help push the bottom of the stalk away from the center of the combine to make the head of the sunflower fall towards the direction of the feeder housing. The high part of the gathering pan located opposite and on top of the ridge bar also helps push the head of the sunflower towards the feeder housing (See Photo 014). For adjusting ridge bar (See Photo 012) simply loosen three (3) bolts, slide ridge bar in or out as desired, and retighten bolts.

For normal operation, the ridge bar should be farthest away from the gathering chain paddles at the front of machine and closer to the paddles at back of machine to create a funneling effect as the stalk moves closer to the platform just before cutting. (See Photo 012)

For excessively large stalks slide the ridge bar as far away as possible from the paddles at both the front and back to create a larger opening for the stalk to pass through.

Direction of feeder housing

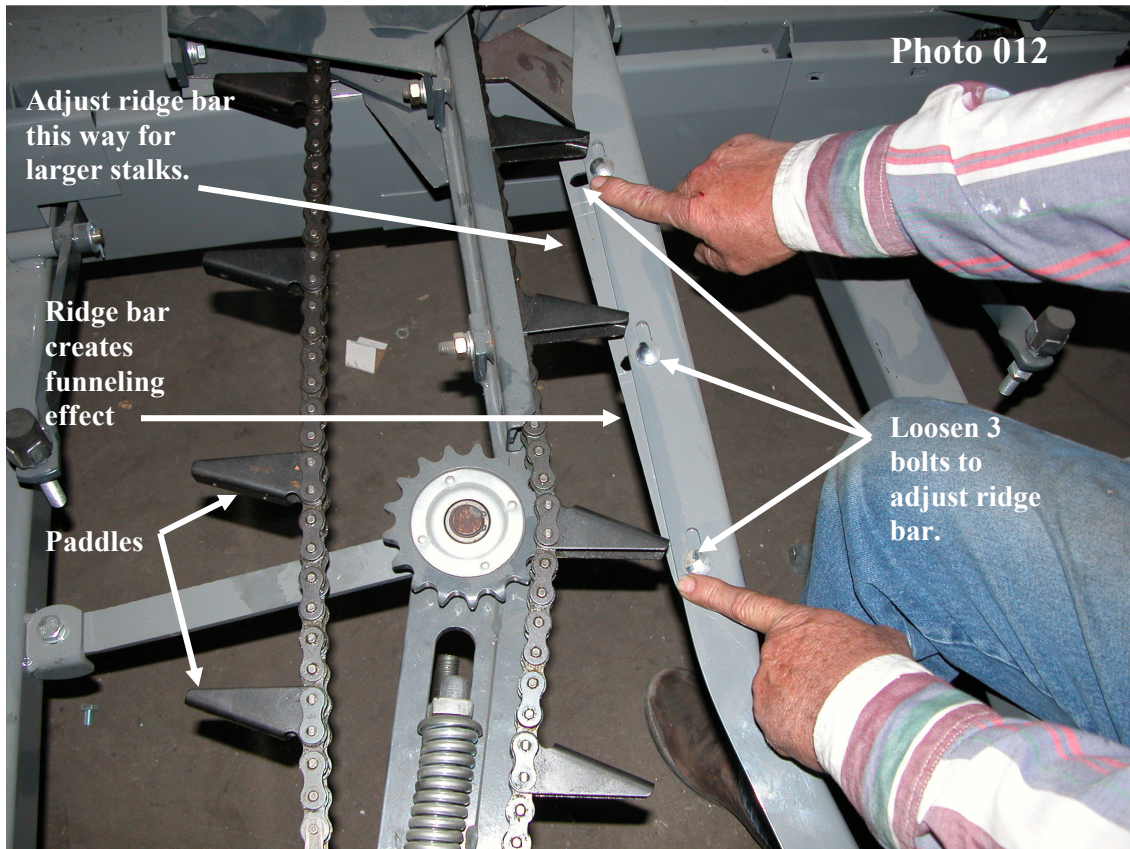

Vibrating Gathering Pans

A rocker arm including a replaceable rubber is positioned underneath the gathering pan. (See Photo 013) The driveshaft connecting the gearboxes includes a cam which pushes the rocker arm up and down. The rubber strikes a thick piece of strap iron on the underside of the pan gently vibrating the pan. Any seeds or heads collected will float towards the platform and into your hopper. (See Photo 014) The replaceable rubber and iron strap protects the pan from wear. To adjust vibration of gathering pan simply loosen the hex nut, turn rubber pad up or down and retighten hex nut. (See Photo 013)

Operate the machine with the least amount of vibration as possible. Excessive vibration will decrease life of the pan and will soon need replacement. The recommended maximum vibration is only 1/16".

Pans should be kept fairly level during operation (See Photo 016) and may even be sloped upwards a few degrees. Pans are held in place by two spring loaded latch pins. (See Photo 015)

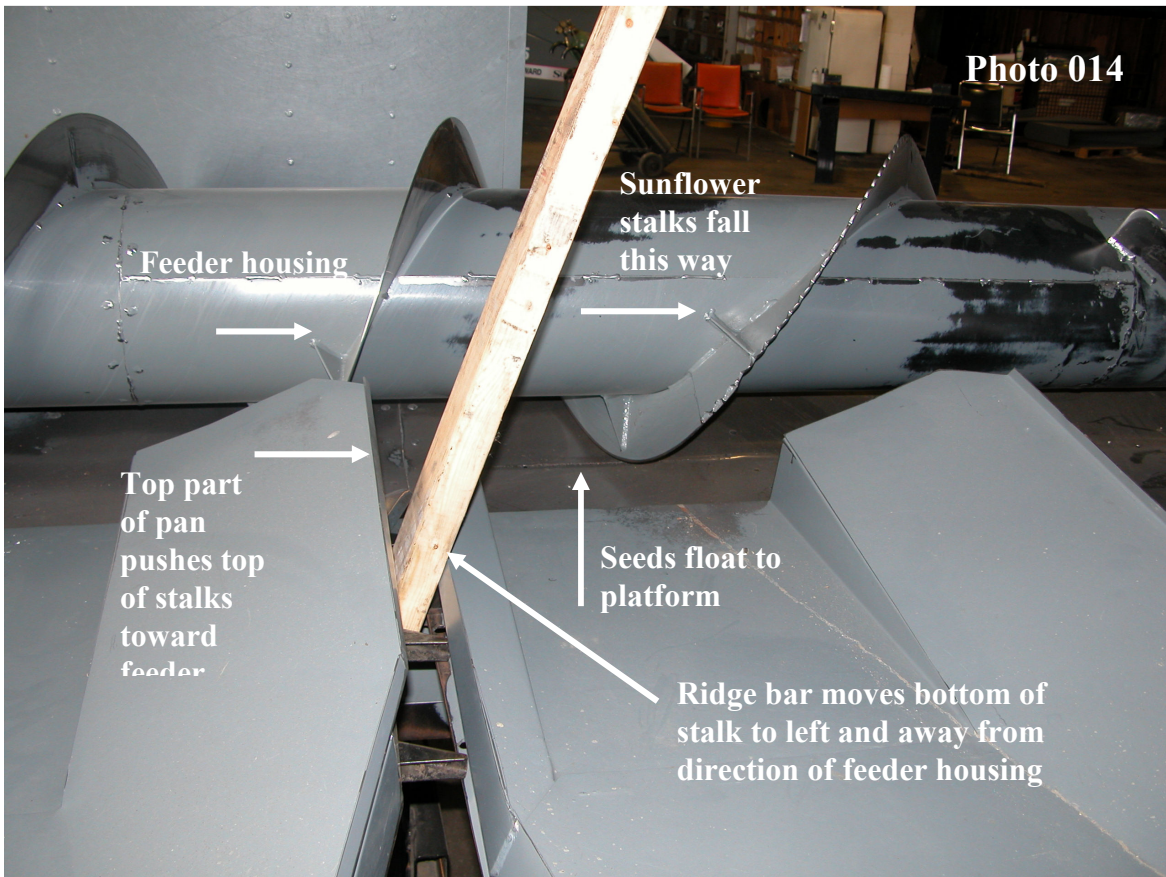
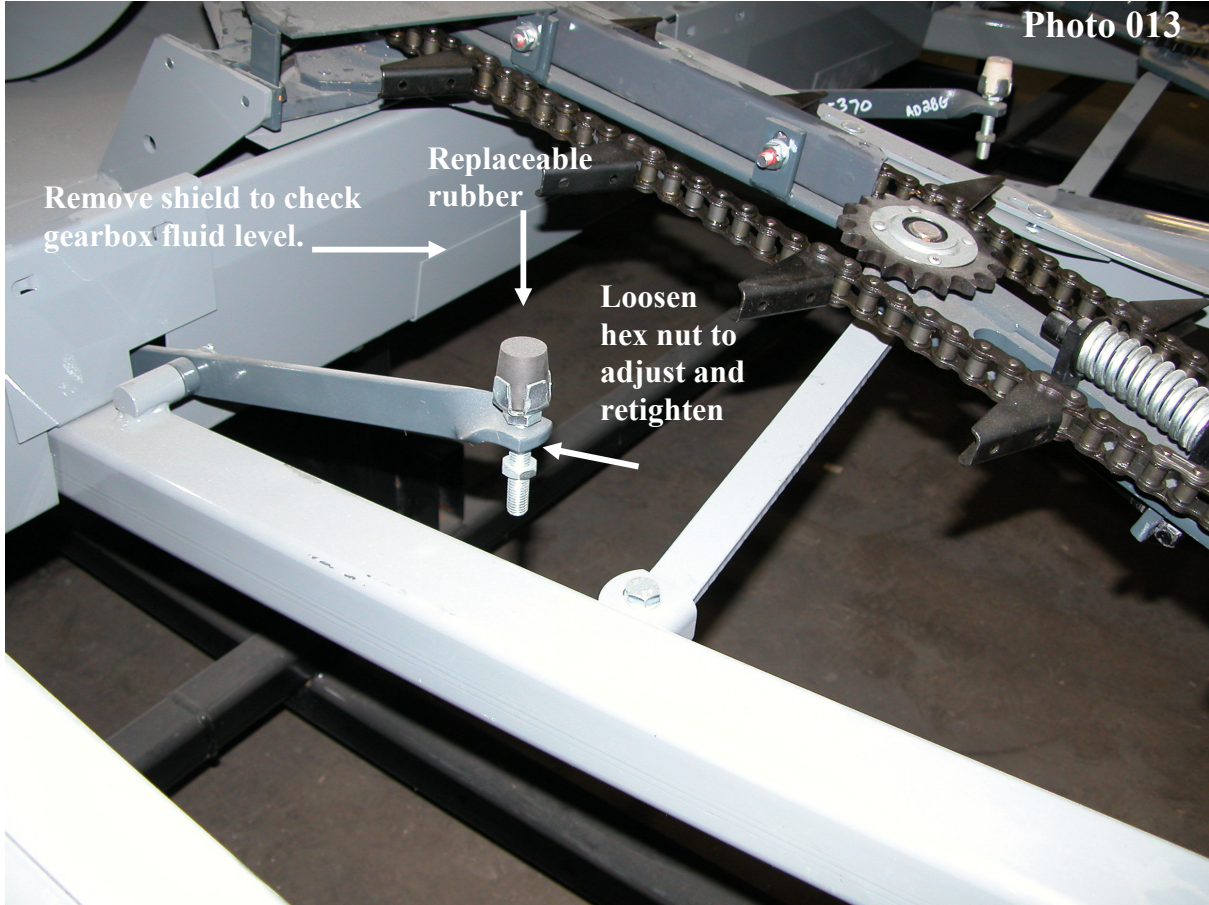

Vibrating Gathering / Catch Pans and Servicing of Gearbox Clutches

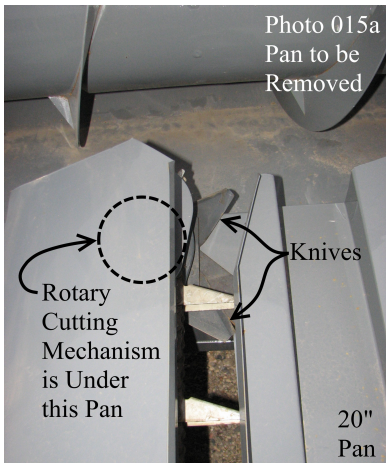

To service the gearboxes, the rotary cutting blades, the cutting head and adjust the tension on the clutch you need to remove the gathering pan above it, **Photo 015a**. You will need the pin release tool(s), and to locate the pins that hold the pan in place. The cones should be down, they are separate.

The header needs to be *up* to gain access. Use **all safety precautions** when doing this work! *Lock combine header cylinder stops in the up position!*

The photo below is a 30 inch pan. The 22 and 20 inch pans bring the lock pins much closer together. Each pan has two locking pins. The bolt slides inward and rotates up into a lock-out slot. **Photo 015e** shows both positions.

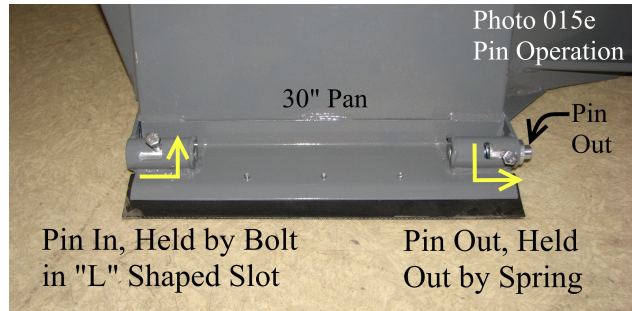

and to locate the pins that hold the pan in place. The cones should be down, they are separate.

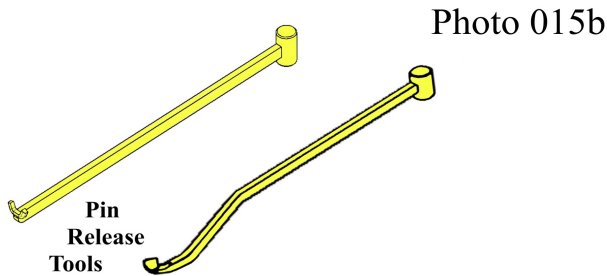
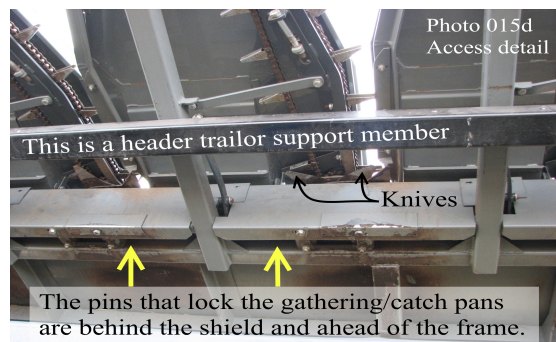
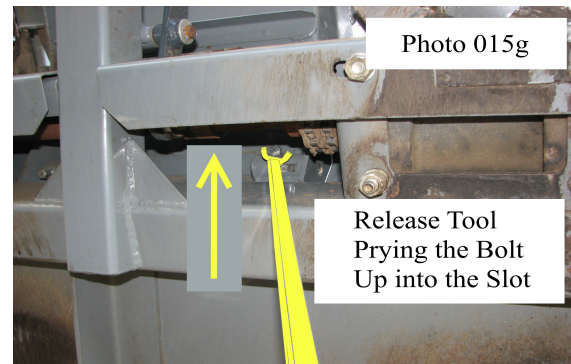
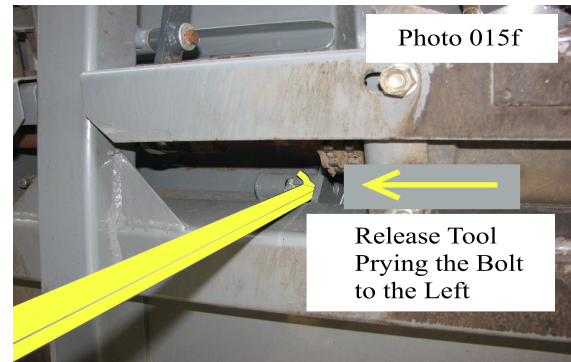

Photo 015b above shows the pin release tools.

Photos 015c and **015d** below show the rather narrow area to access the pins.



Best Angle for Seed Flow



There is one gearbox for each of the rotary cutting knife units. The gearbox is completely sealed with three (3) replaceable seals and is filled with #90. Do not overfill the gearbox. With heat buildup the fluid will expand, damaging the seals and causing them to leak. Fill to recommended level of ¼” below plug. (See Photo 017) Gearbox level should be checked annually. To check gearbox level requires removing the gathering pans and protective shield in front of gearbox. (See Photo 013) Use allen wrench to dip and check level. **If fluid flows out of the plug the level is too high and will damage the seals causing the gearbox to leak. When checking fluid level, make sure that gearbox is level. Operator may have to raise or lower platform accordingly.**

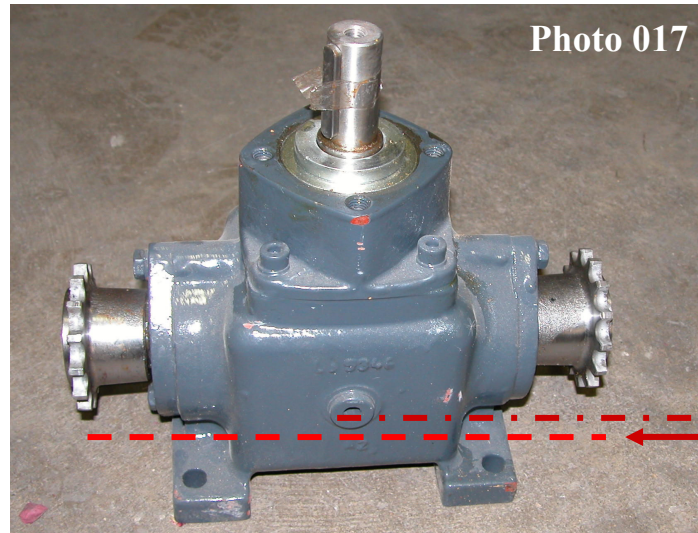

Fill to no more than ¼” below plug

The driven sprocket on the left side of the machine (See Photo 010) turn the left gearboxes and they turn clockwise. The driven sprocket on the right side of the machine (See Photo 011) turn the right gearboxes and they turn counterclockwise.

There is a shaft between each gearbox. It connects between each gearbox with two (2) sprockets and a coupler chain. (See Photo 018) The coupler chains are Metric #10 and are available from your dealer. A shoulder on the connecting shaft keeps sprocket couplers in place and there is no set screw. (See Photo 019)

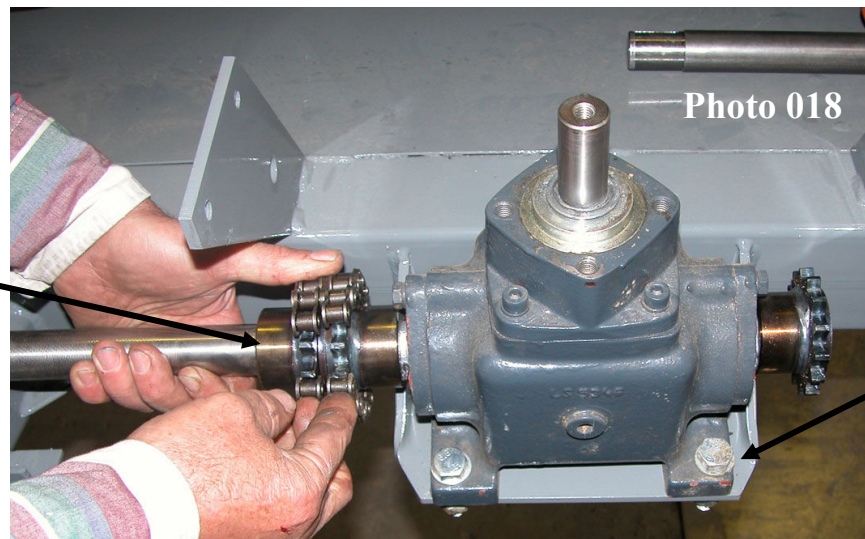

Remove coupler to lift out gearbox

Remove 4 bolts to lift out gearbox.

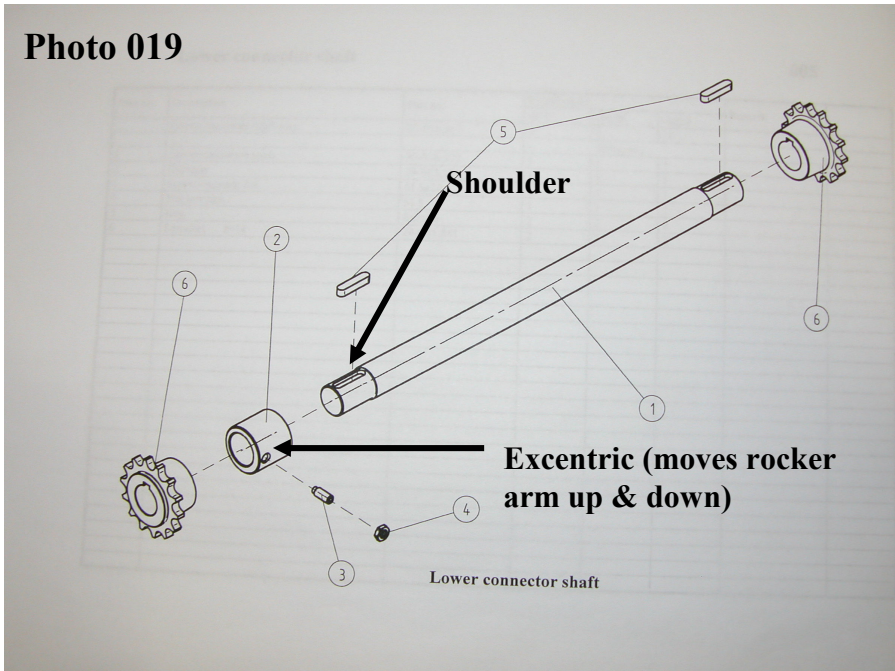

In the middle of the 8 row machine, the shaft of the #4 gearbox driven from the leftside of machine and the connecting shaft driven from the rightside of the machine are housed in a bearing but turn independently. The same design is for a 12 row machine, instead using the #6 gearbox. (See Photo 020) The bearing housing shown in Photo 020 is not self aligning. It is critical that the bearing that houses the left and right shafts be properly seated and aligned or problems may occur.

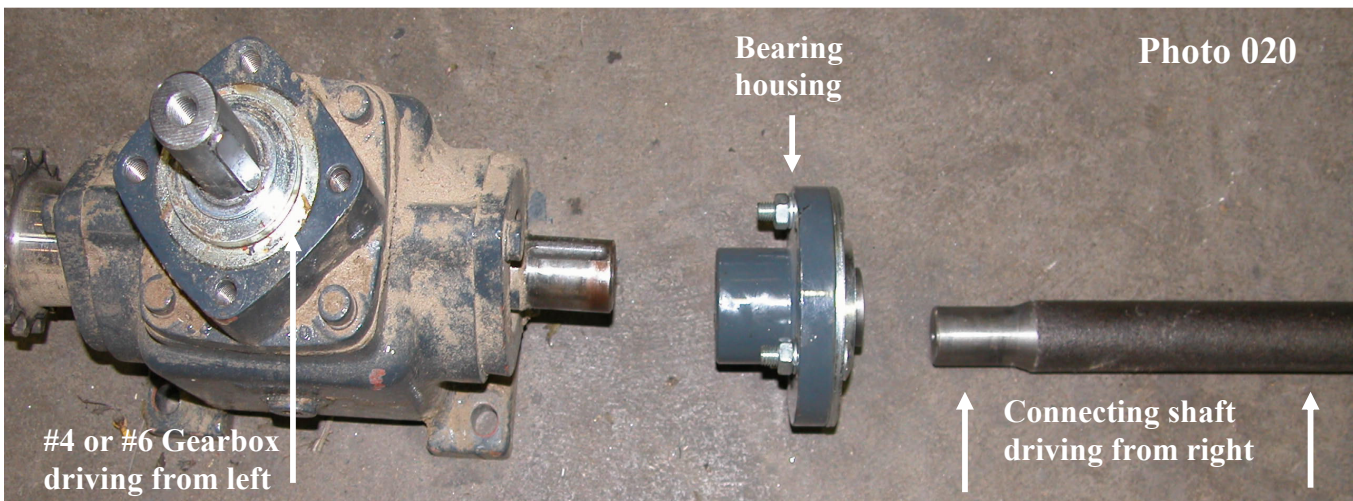

LEFT OF MACHINE

RIGHT OF MACHINE

Looking from back of header

The outside coupler sprockets on the left and right gearboxes are set at the factory (See Photo 034) to ensure proper alignment throughout entire line of gearboxes and drive connecting shaft.

When either of the outside left or right gearboxes are removed it is important to recheck proper alignment when gearboxes are put back on.

For leftside transmission shaft assembly alignment::

Loosen four (4) transmission shaft assembly bolts. (See Photo 010) Connect outside and inside sprockets with chain coupler. (See Photo 034) Position assembly as needed and retighten four (4) bolts. Same procedure used for right side transmission shaft assembly alignment.

Gearboxes may be removed independently for replacement or further servicing. To remove gearbox first remove gathering pan, rotary cutting knife and shield. Then remove chain coupler on each side of the gearbox and four (4) bolts holding down the gearbox to the mainframe (See Photo 018). Then lift out gearbox. The gearbox includes three (3) replaceable seals (See #11, #20 Photo 021) Expect some additional wear on the outermost left and right side of the machine to the coupler sprockets and components inside the gearbox.

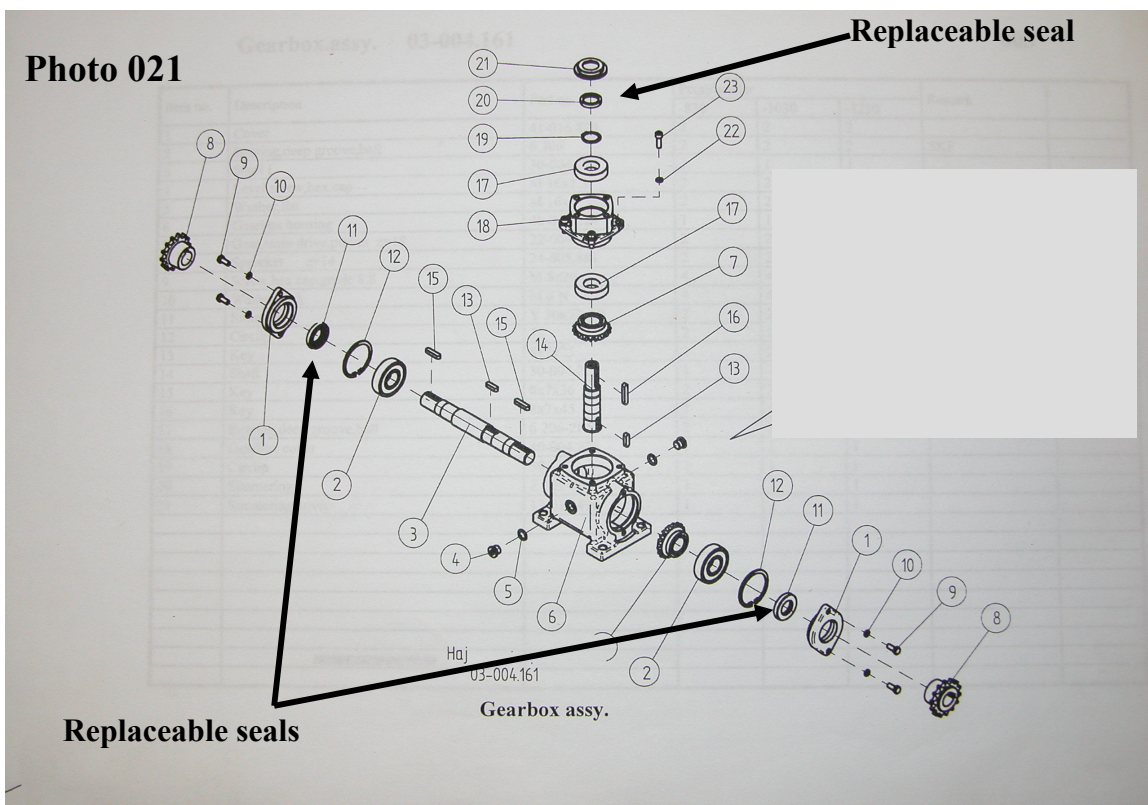

Gearbox clutches

Each gearbox is equipped with its own clutch. It is recommended that the clutch be tightened to 120 ft/lbs. Experience has shown to tighten clutch down nearly as much as possible to allow the drum clutch to slip. To tighten clutch start by tightening all the way down then back off. Sunmaster comes with special tools to tighten down clutches. (See Photo 023) Photo 022 shows breakout of all components of rotary cutting knife assembly and clutch components.

To take apart clutch bend top lock washer (#9 Photo 024) and remove top bolt and washer (#10, #8 from Photo 024). Now entire rotary cutting unit lifts off. To disassemble clutch unloosen nut (#18 Photo 025). When removing the various components, be sure to keep them in proper order for re-assembly. The spring disk compression washers (#16 Photo 026) must be in the convex position when re-assembled. Each clutch contains two (2) friction plates top and bottom (#12 Photo 027). **When installing new clutch friction plates don't forget to change bottom friction plate as well (#12 Photo 028).**

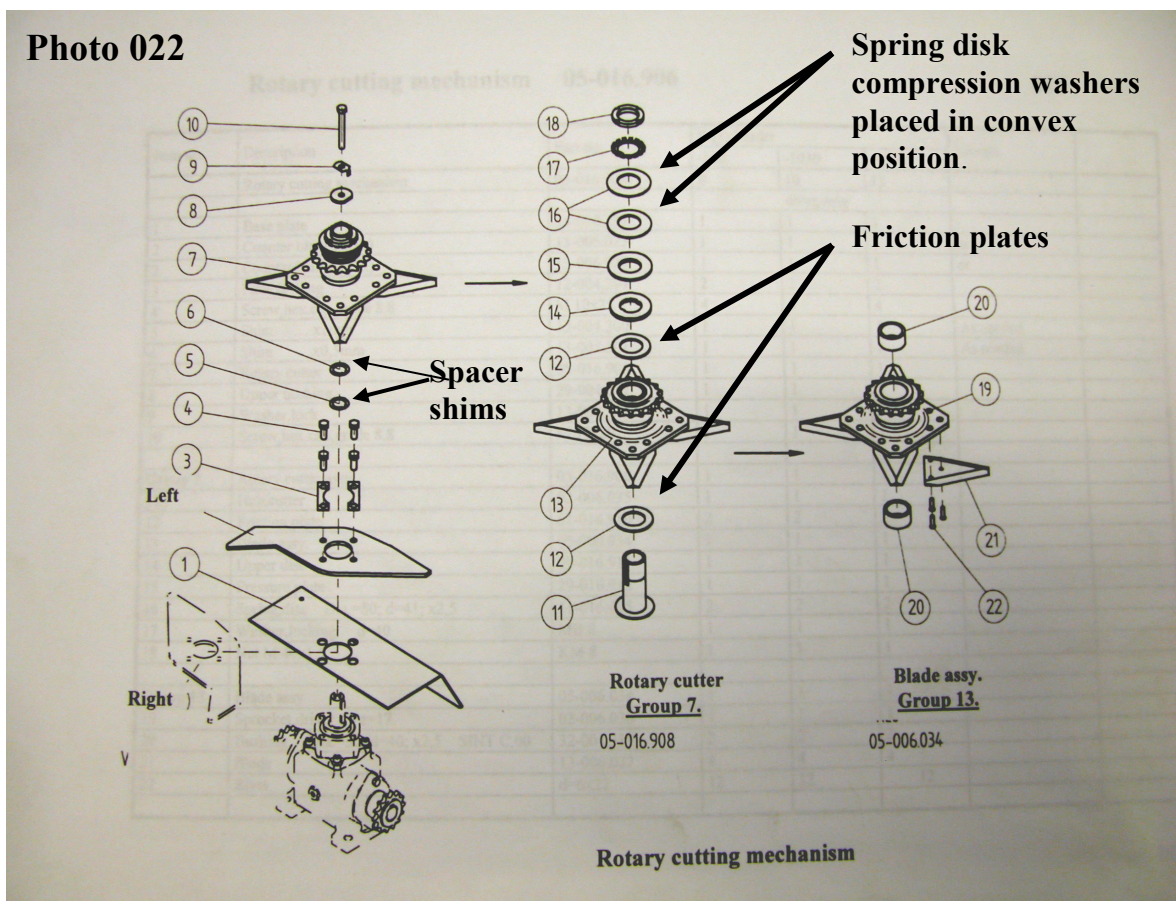



Photo 024



Photo 025

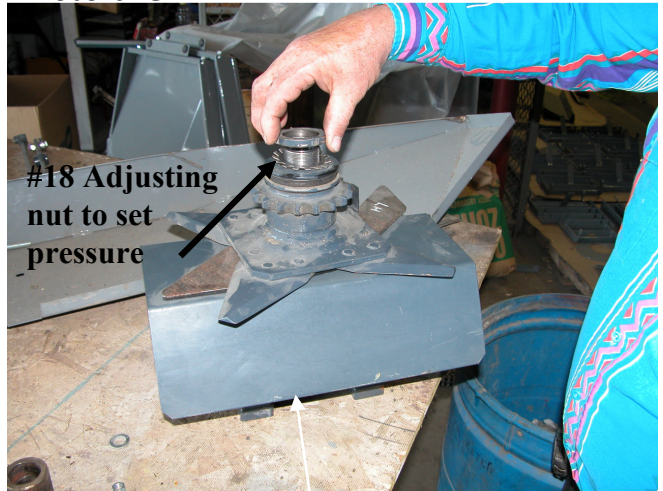

Photo 026



Photo 027



Photo 028

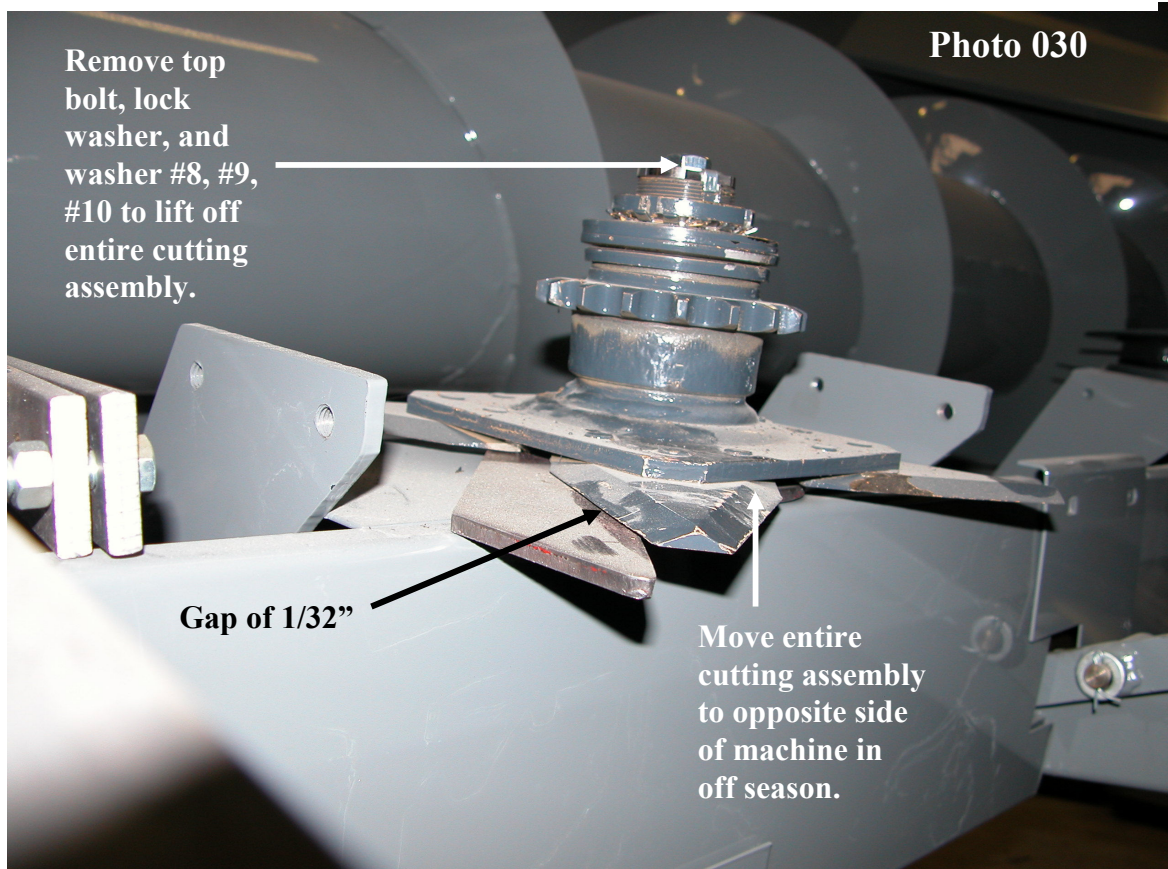

Photo 029



Rotary Cutting Knives

Each rotary cutting knife assembly includes four non-corrugated heat-treated knives. The recommended gap between the rotating knives and the stationary knife is 1/32" and **should be kept as close as possible without rubbing against the stationary knife.** (See Photo 030) Any rubbing will cause additional wear on stationary knife and the various components of the machine. The gap is preset at the factory by installing two spacer shims each of a different width (#5, #6 Photo 029).



To change knives there is no need to remove the gearbox. Simply remove top nut (See Photo 030), pull off rotary cutting unit and put on the bench to remove rivets. If one knife needs replacing there is no need to replace the other three (3) knives as the unit will stay in balance while spinning. Sunmaster units are delivered from factory with two extra cutting knives and rivets. Operator may choose to replace rivets with countersunk bolts if desired.

The rotary knife assembly uses only one side of the rotating knives. The knives on the left side of the machine turn in opposite direction from the knives on the right side machine. To utilize the backside of knives thereby extending its life, simply move the rotary cutting units to the other side of the machine during the off season.

The stationary knife cannot be moved to other side of the machine but can be sharpened.

Drum

The recommended drum height comes preset from the factory with a clearance of $\frac{3}{4}$ " to $\frac{7}{8}$ " from the edge of the rib to the platform. (See Photo 031)

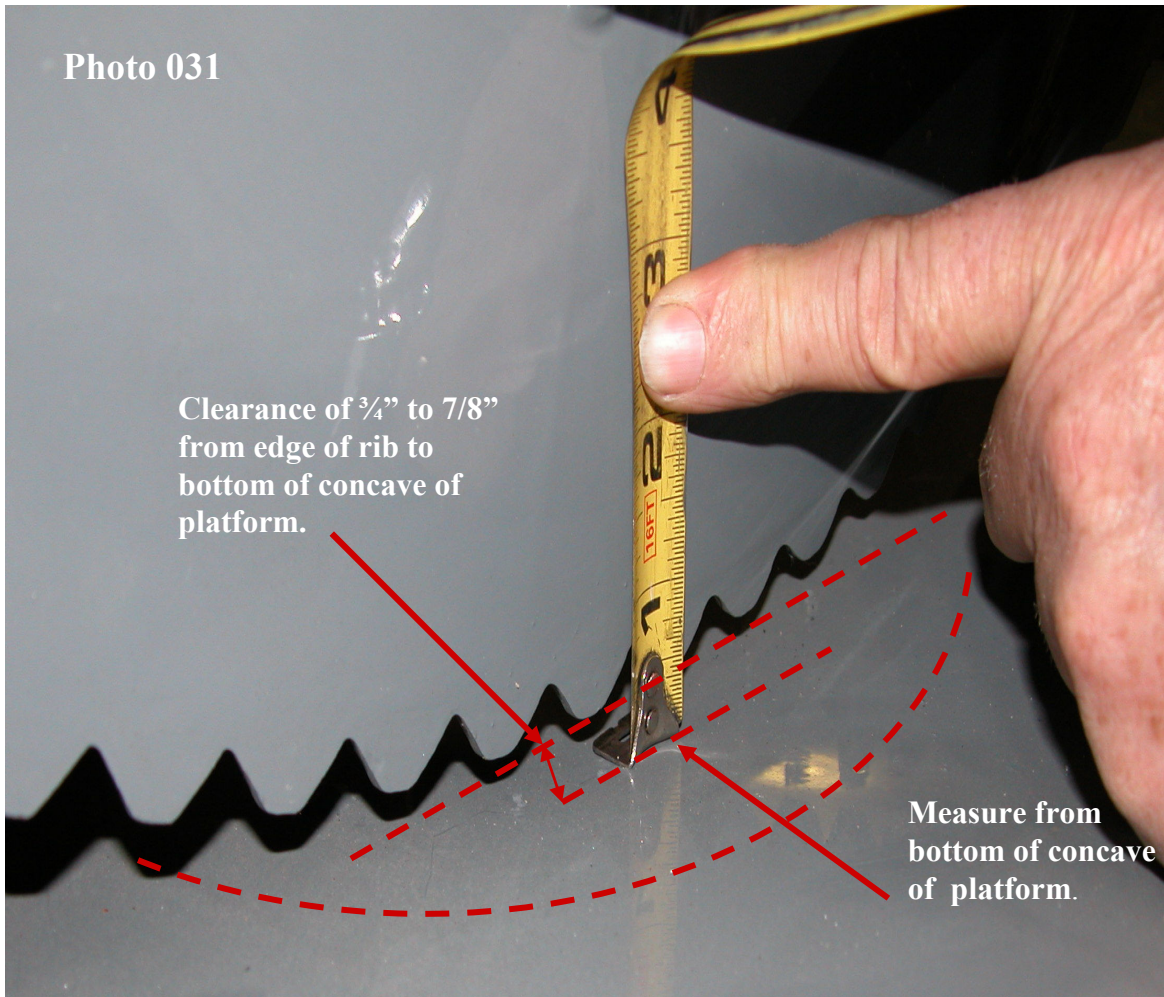

To change the height of the drum (See Photo 032). Loosen four (4) bolts behind the inner drum sprocket on both the left and right side of the machine to allow drum to slide up or down. Then turn top adjusting bolt. Adjust evenly from both left and right side of machine. When proper height is attained re-tighten four (4) bolts on both sides of machine.

There are no fingers on the drum. In the front of the feeder housing the flighting is ribbed and comes past center from each direction. This design helps ensure smooth feeding. A stripper bar welded on the platform behind the drum helps prevent wrapping of crop around the drum.

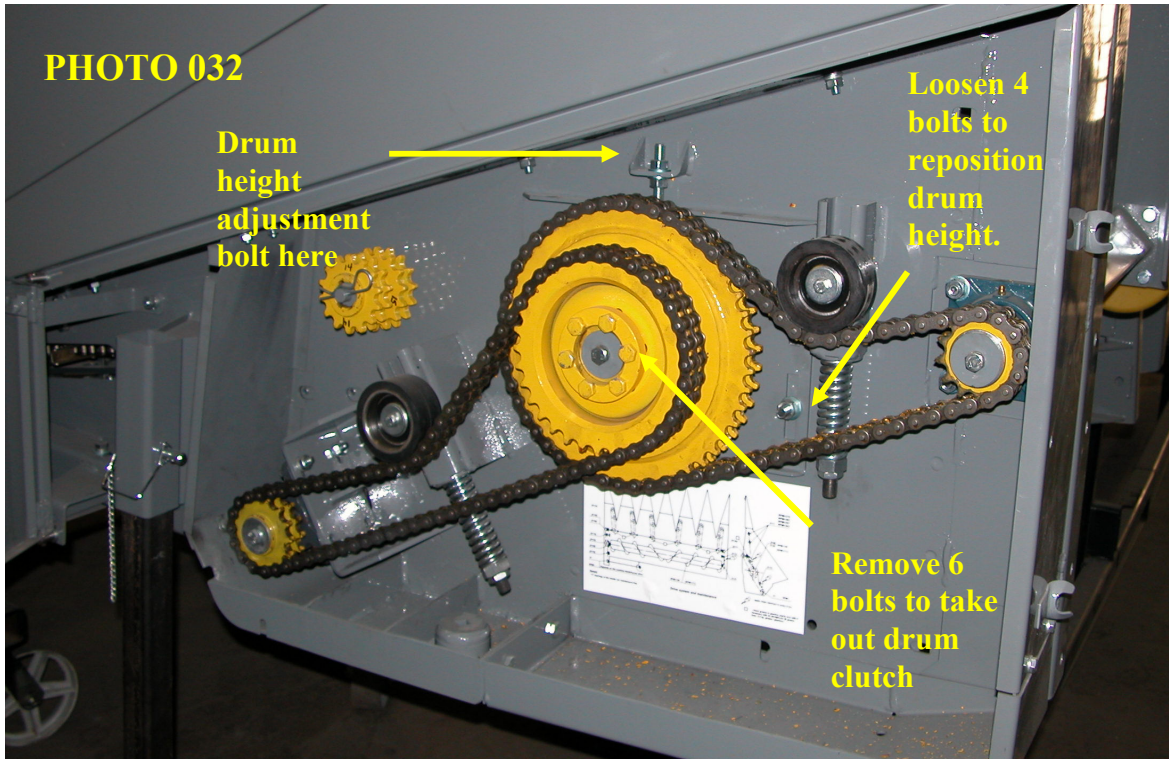

Left side of machine

On single drive machines the drum clutch is tightened to 600 ft/lbs. on an eight (8) row machine or 900 ft/lbs on 12-row machine. For double drive machines use 900 ft/lbs on left side and 500 ft/lbs. on right side. Clutch on 8 row unit includes two (2) springdisk pressure plates and the clutch on a 12 row unit includes three (3) springdisk pressure plates. See Photo 033) There are four (4) friction plates on either the 8 or 12 row units. To remove drum clutch remove 6 bolts shown in Photo 032.

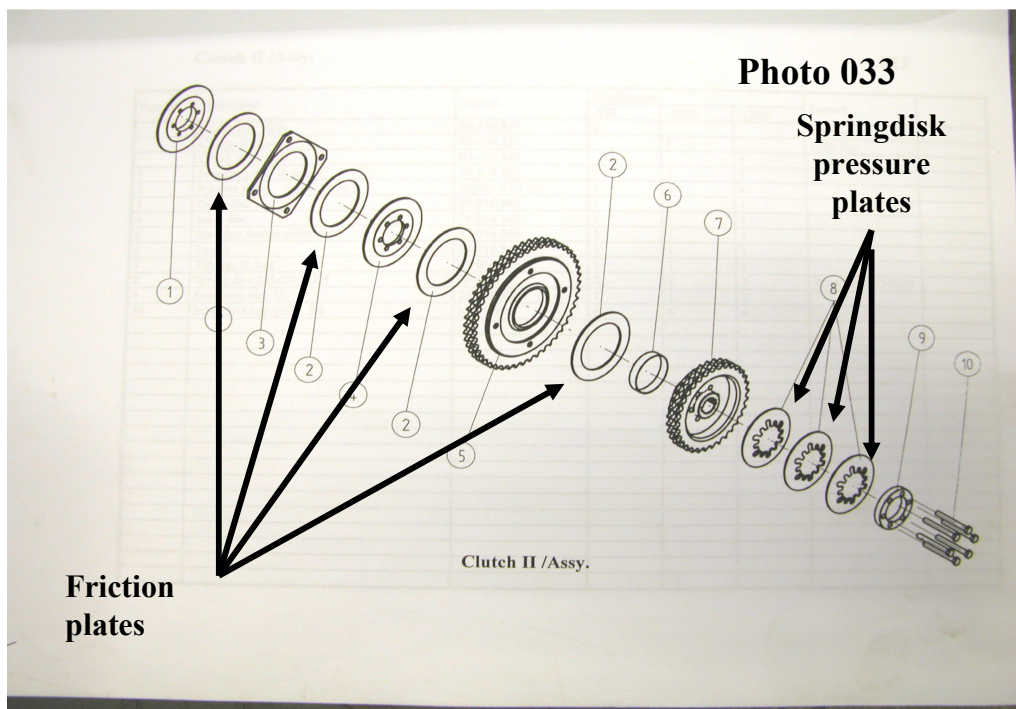

There is a shaft bolted on at each end of the drum that connects to the drum sprocket. To remove shaft see Photo 034 for location to insert socket wrench.

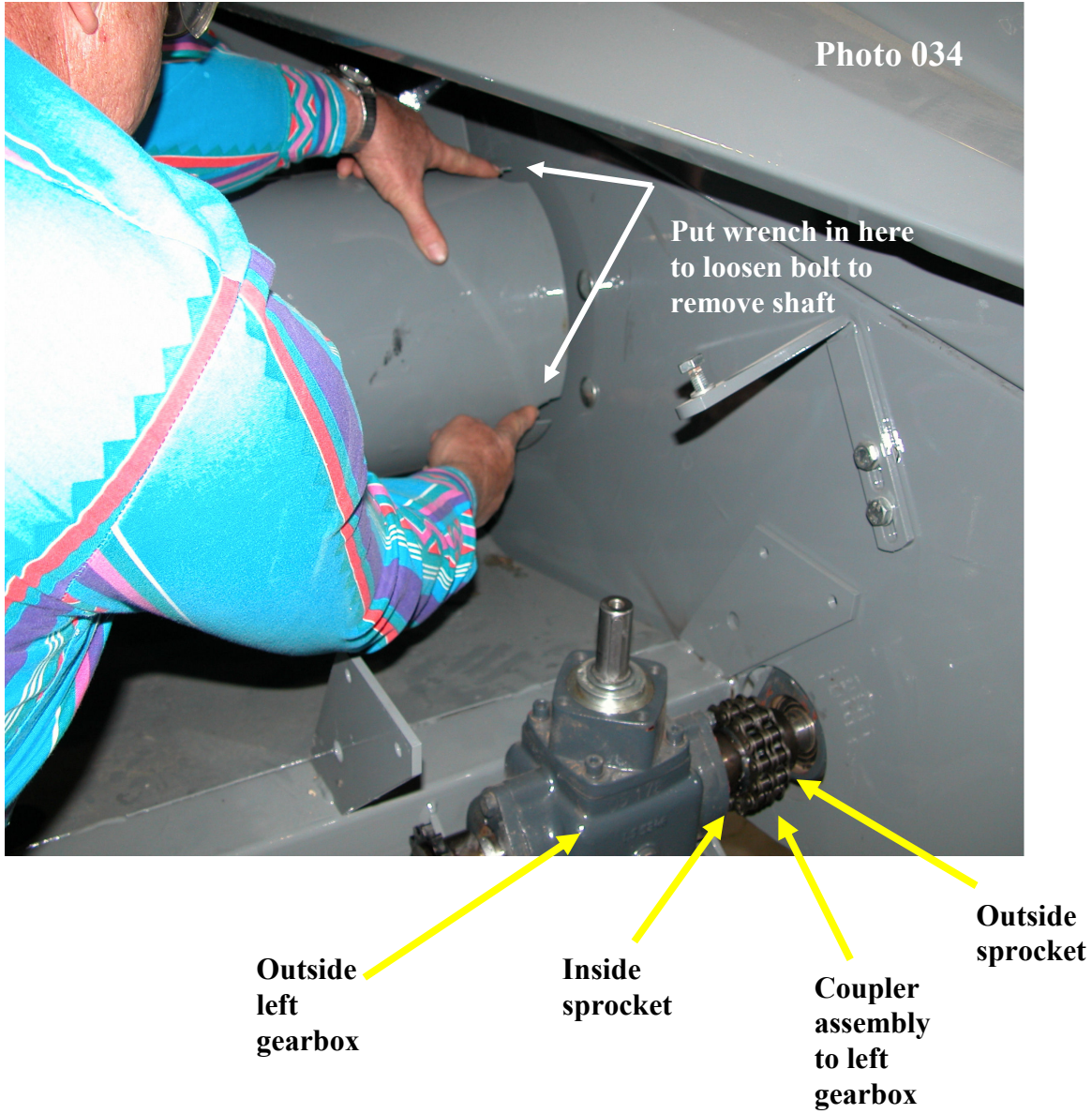

Row Dividers

Row dividers are available in standard and longer length. (See Photo 035) Unless specified, units shipped from the factory are equipped with the standard length dividers. Inquire at your dealer for the longer length dividers. The longer length dividers are recommended for milo that is lodged. Row dividers move up and down independently from each other. Skid shoes are designed to slide along on the ground. The row dividers flip up and lay on top of the pans for transport. Two adjusting bolts on the underside of the divider set the downward angle of the row dividers. (See Photo 036)

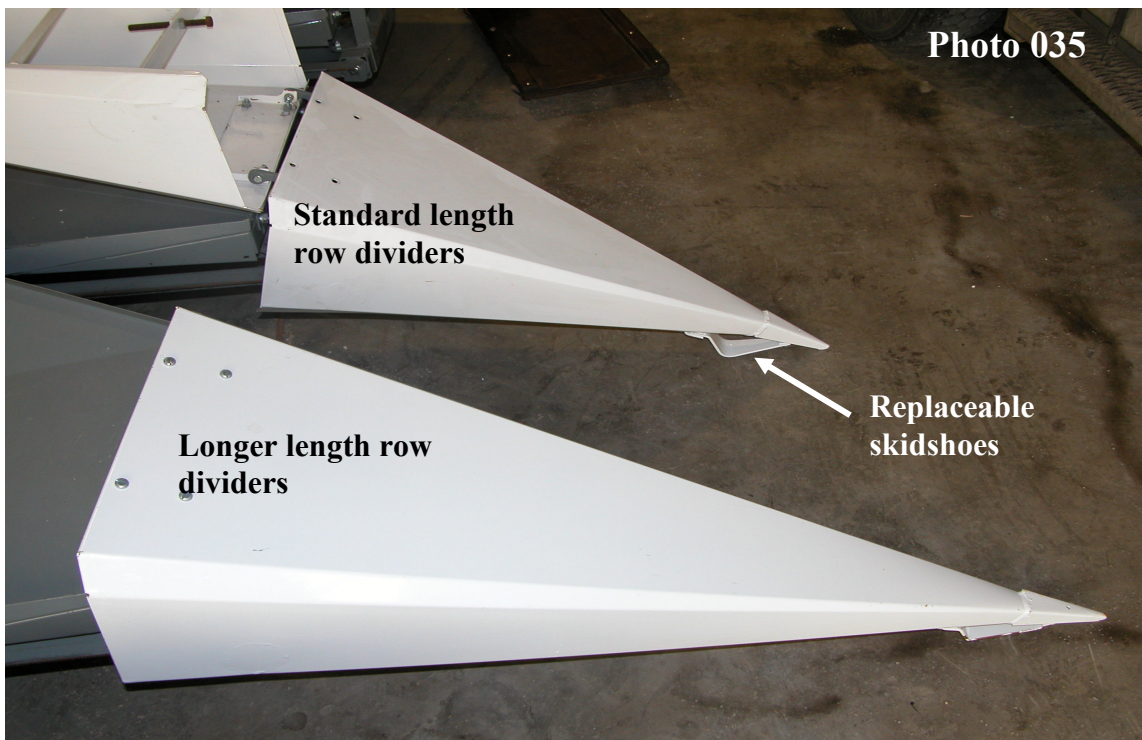

The dividers will help lift the stalks up before cutting them off. Operator may adjust the bolts so that the row dividers have the maximum angle downwards. In this way the operator can get as low as possible to the ground and still keep the platform higher off of the ground. With maximum downward angle of the row dividers and with the skid shoes sliding along on the ground in any crop, the operator must be watchful for irrigation tracks or other deep holes or ruts in the ground. If not careful the point of the row dividers could drop into a track or rut and possibly buckle up to cause damage.

Setting the row dividers with more downward angle helps keep the platform off of the ground and the gathering pans more level. With less downward angle on the row dividers, the operator may lower the platform but then the upward angle of the gathering pan is increased. Even with a slight upward angle of the gathering pans, any seeds can still float back to the platform. However with too much of an upward angle on the pans the seeds will no longer float back to the platform. Operator may drop the point of the row dividers to a steeper angle which allows the operator to raise the platform and thus leveling out the pans.

When running the platform as low as possible the distance between gearbox and ground level is reduced and operator needs to watch for possible buildup of crop residue underneath. The vibrating pans work best when the platform is operated nearly as level as possible.

In lodged milo operator may want to use the longer length dividers and adjust the downward angle of the row dividers accordingly, so that the platform can be run higher off of the ground. In this way the rotating cutting knives will cut the stubble off at a taller height.

Some newer combines have a manual adjustment to change the angle of the header to the feeder housing. When operating in sunflowers the operator may want to change the header angle to tilt it more backward. In this way the vibrating gathering pans can be kept more level. If operating in lodged milo, the operator may want to tilt the header angle more forward so that the platform is kept as high off the ground as possible in order to leave the maximum height stubble standing. While this increases the upward angle of the gathering pans and makes it more difficult for the seeds to float back to the platform, it is not as critical because there is less chance of shattering in milo.

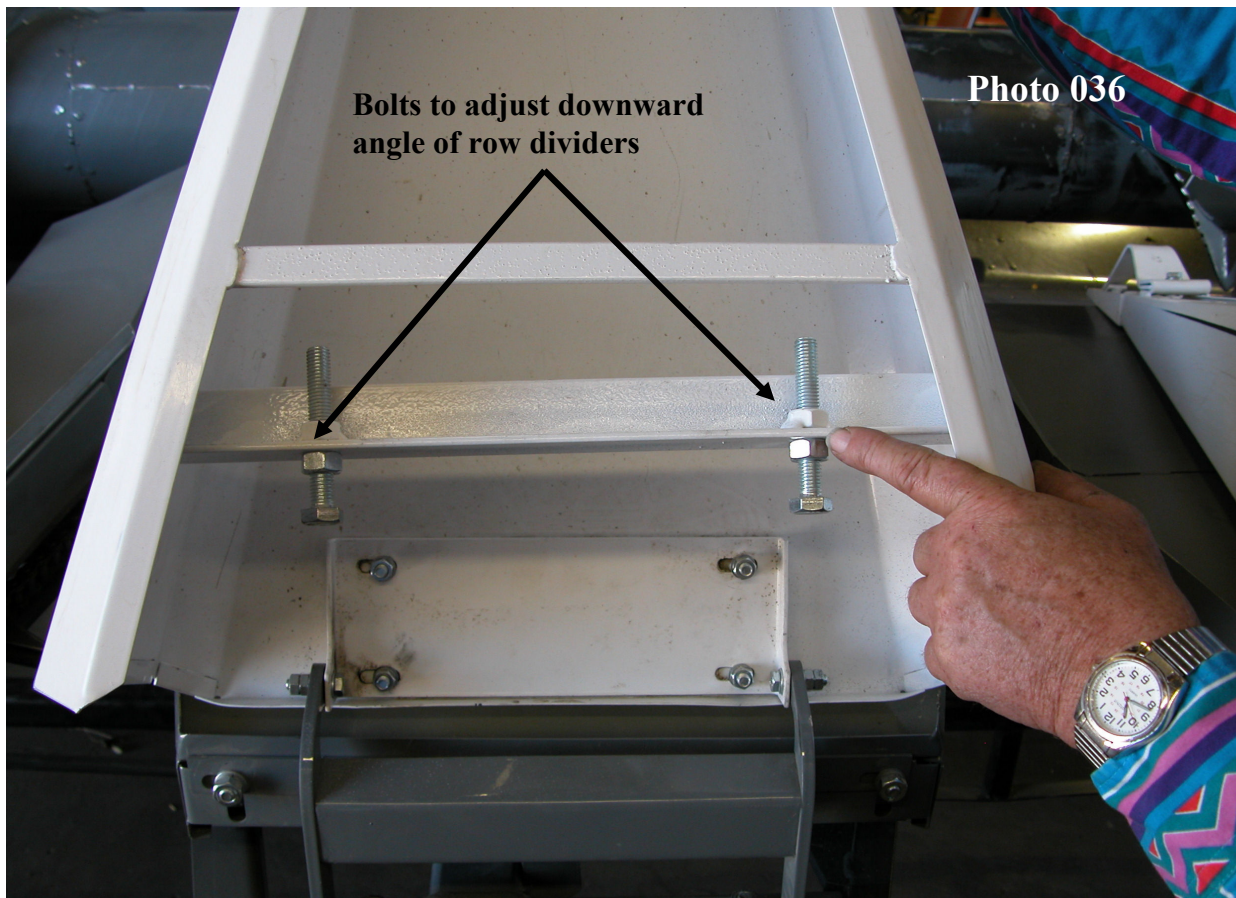

Single Drive

The 8 row x 30" and 12 row x 30" row units are built as single drive. The 12 row x 20" row unit also incorporates a single drive. The 16 x 20 and 18 x 20 row units are built as double drive units.

Single drive operates from the left side of the feeder housing as follows: (Refer to figure on next page.)

On single drive the auger drum has one clutch on the left side of the drum and is tightened to 600 ft./lbs. on the 8 row machine and 900 ft./lbs. on the 12 row machine. For both 8 and 12 row units the inside and outside drum sprockets on the left side of the machine are 48 teeth and 33 teeth. The right side drum sprocket is 33 teeth. These sprockets are the same regardless of combine model (John Deere, Case-IH, New Holland, CAT, Gleaner) The sprockets are all double teeth. The drive chains are Metric #12.

Left Hand Single Drive

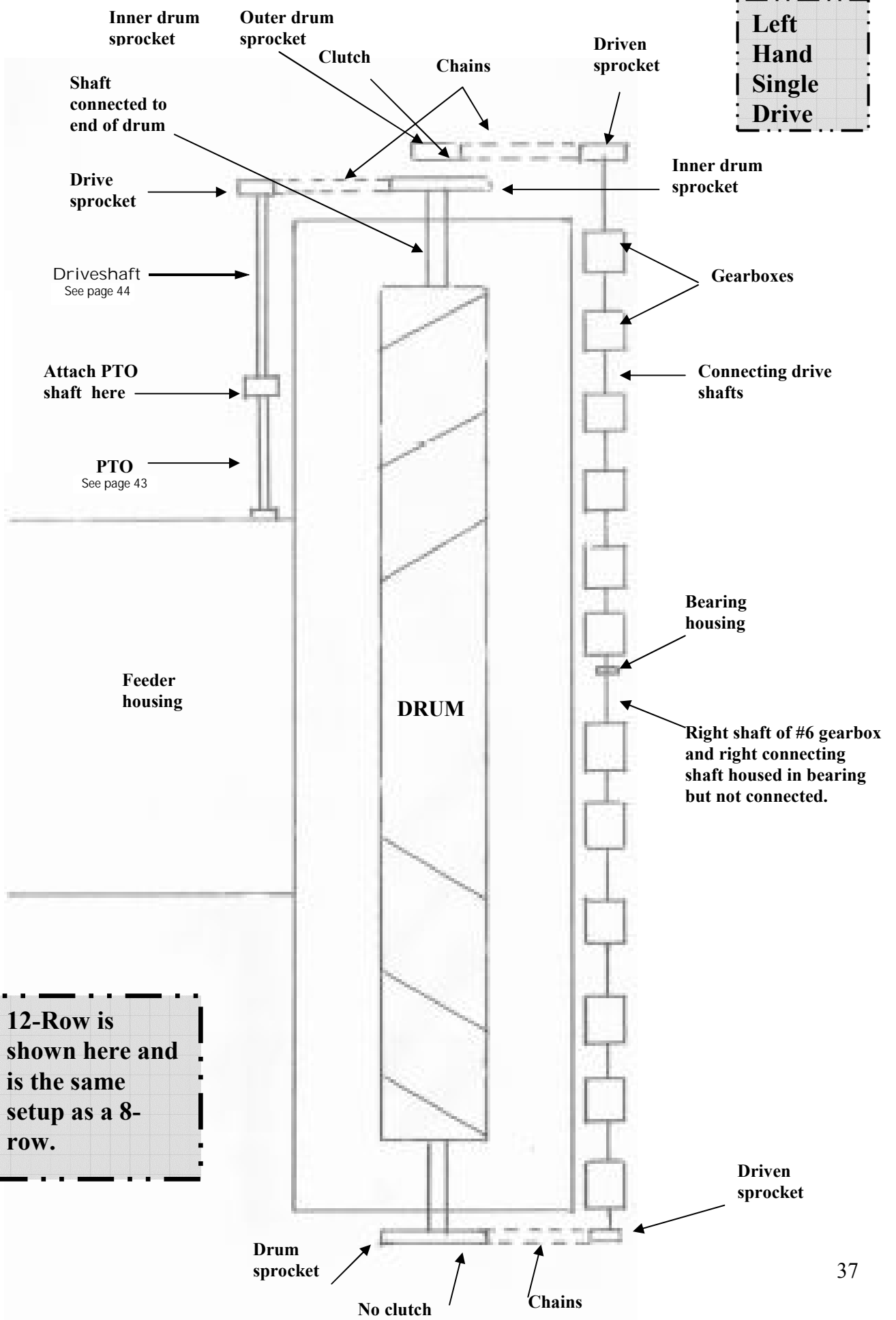

12-Row is shown here and is the same setup as a 8-row.

Double Drive

Double drive operates from both the left and right side of the feeder housing as follows:
(See Figure on the next page).

On double drive headers the auger drum has clutches both on the left and right side of the drum. The left hand clutch is tightened to 900 ft/lbs. The right hand clutch is tightened to 500 ft/lbs. The number of teeth on both inside and outside drum sprockets are the same as single row drives.

For the right side clutch there is no key on the drum shaft (See Photo 037). This allows the clutch to free wheel. The right side is driving the right side gathering chains only and the left side is still driving the entire auger drum. The advantage of the double drive is reduced stress on the left side shaft of the auger drum. With double drive there still is chance for additional wear on extreme right side and left side gearboxes.

Double Drive

Left side clutch is keyed

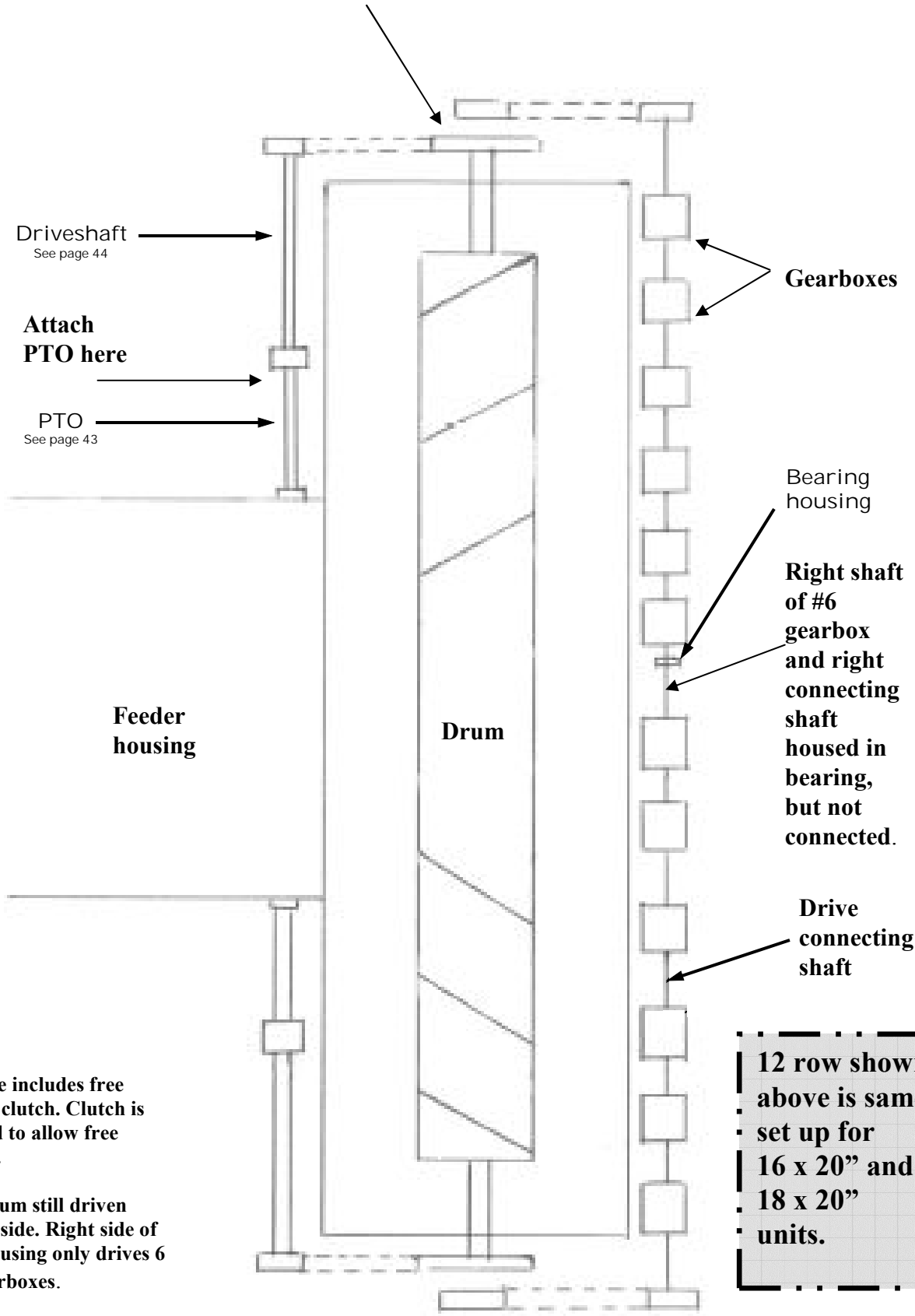

Driveshaft
See page 44

Attach
PTO here

PTO
See page 43

Feeder
housing

Drum

Gearboxes

Bearing
housing

Right shaft
of #6
gearbox
and right
connecting
shaft
housed in
bearing,
but not
connected.

Drive
connecting
shaft

12 row shown
above is same
set up for
16 x 20" and
18 x 20"
units.

Right side includes free wheeling clutch. Clutch is not keyed to allow free wheeling.

Auger drum still driven from left side. Right side of feeder housing only drives 6 right gearboxes.



Photo 037

No key on this clutch to allow free wheeling

Right side of Double Drive System

ADAPTERS

Sunmaster Headers are delivered with an adapter to couple the header to the customers combine feeder housing. This information needs to be specified at time of order.

The following table gives combine, adapter kit numbers and weldment numbers.

Combine Manufacture	Model or Series	Special Fit Feature	Adapter Kit No. Single Drive *	Adapter Kit No. Dual Drive **	Weldment No.
Cat	Lexion	Auto Contour	JHE1000	JHE1000 Dual Drive	JHE501C
Gleaner	R Series		JHE1001	JHE1001 Dual Drive	JHE508
Case IH	2300 Series		JHE1002	JHE1002 Dual Drive	JHE510
New Holland	CR Series		JHE1003	JHE1003 Dual Drive	JHE511EXT
Case IH	7000 and 8000 Series		JHE1004	JHE1004 Dual Drive	JHE511EXT
John Deere	60 Series		JHE1005	JHE1005 Dual Drive	JHE525
Gleaner C / Massey			JHE1006	JHE1006 Dual Drive	JHE535
Cat	Challenger	(multi-fit)	JHE1007	JHE1007 Dual Drive	JHE550
New Holland	TR and TX Series		JHE1008	JHE1008 Dual Drive	JHE513B
New Holland	CX860		JHE1009	JHE1009 Dual Drive	JHE505
Gleaner	R & S Series	Auto Contour	JHE1010	JHE1010Dual Drive	JHE540
Gleaner	S Series	Offset Contour	JHE1011	JHE1011 Dual Drive	JHE545

* The 6 row 30, 8 row 30, 12 row 20 and 12 row 30 are single drive headers

** The 16 row 20, 18 row 20 and 16 row 30 are dual drive headers

For PTO and driveshaft information see pages 43 and 44

Telescoping PTO and Driveshaft

Sunmaster units delivered include telescoping PTO shaft to connect to feeder housing shaft on the combine. Female right side of telescoping PTO shaft is matched to male end spline on combine and is specified on order. The male 540 spline driveshaft of the Sunmaster is positioned differently on the 8 and 12 row units so that the same length telescoping PTO shaft can be used for either the 8 or 12 row units. (See Photo 036)

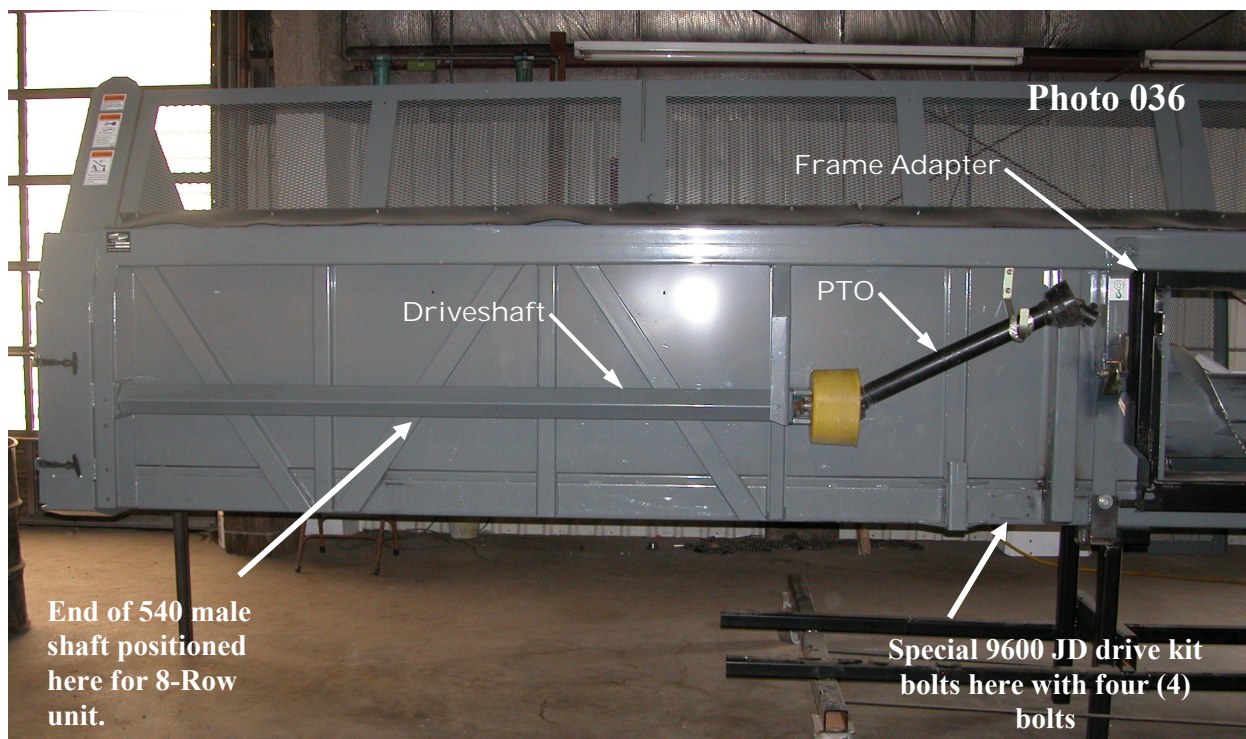

Photo 12 Row Unit

SUNMASTER PTO CHART

35 Series

NARROW HEADER MODELS		WIDE HEADER MODELS*	
6 Row 30, 8 ROW 30, 12 ROW 20		12 ROW 30, 16 ROW 20, 18 ROW 20, 16 ROW 30	
PTO Part No. **	COMPRESSED LENGTH & YOKE	PTO Part No. **	COMPRESSED LENGTH & YOKE
JOHN DEERE 60 SERIES	903-18088 35E X 26, 1-3/8 X 21 SPLINE	903-18085 35E X 48, 1-3/8 X 21 SPLINE	
CASE 2388	903-18091 35E X 34, 1-1/8 HEX	903-18086 35E X 48, 1-1/8 HEX	
CASE 8000 & 9000 SERIES	903-18087 35E X 26, 1-3/8 X 6 SPLINE	903-18084 35E X 48, 1-3/8 X 6 SPLINE	
LEXION	903-18088 35E X 26, 1-3/8 X 21 SPLINE	903-18085 35E X 48, 1-3/8 X 21 SPLINE	
AGCO CHALLENGER	903-18088 35E X 26, 1-3/8 X 21 SPLINE	903-18085 35E X 48, 1-3/8 X 21 SPLINE	
AGCO GLEANER	903-18088 35E X 26, 1-3/8 X 21 SPLINE	903-18085 35E X 48, 1-3/8 X 21 SPLINE	
AGCO MASSEY	903-18088 35E X 26, 1-3/8 X 21 SPLINE	903-18085 35E X 48, 1-3/8 X 21 SPLINE	
NEW HOLLAND CR/CX	903-18094 35E X 34, 1-3/8 X 6 SHORT SPLINE	903-18093 35E X 48, 1-3/8 X 6 SHORT SPLINE	

NOTE: PTO LENGTH IS MEASURED BETWEEN BEARING CENTERS.

PTO - CONNECTS THE COMBINE FEEDER HOUSING DRIVE TO THE HEADER DRIVESHAFT

* SERIAL NUMBERS M11650 & PRIOR (4/16/2011 & PRIOR) USE NARROW HEADER DRIVESHAFTS.

** THESE PART NUMBERS REPLACE THE NUMBERS ON PAGE 45. CHANGE EFFECTIVE WITH 2013 MODELS. ALL PREVIOUS MODELS WILL USE THESE PARTS AS REPLACEMENT OR SERVICE PARTS.

Sunmaster Driveshaft & Guard Part Numbers - Lengths Change Serial Numbers and/or Dates

MODEL #	MODEL	S/N OR DATE RANGE	DRIVESHAFT ASSY PART #	DRIVESHAFT PART #	DRIVESHAFT LENGTH, INCHES	GUARD PART #	GUARD LENGTH, IN
00-016-624	8 ROW 30	ALL	01-001-831	30-016-891	40.79	02-016-898	27.80
00-016-625	12 ROW 30	S/N M11650 & PRIOR	01-001-832	30-016-892	100.79	02-016-899	87.76
00-016-625	12 ROW 30	AFTER S/N M11650	01-001-835	30-016-894	70.79	02-016-901	57.76
00-016-626	12 ROW 20	2010 & AFTER	01-015-774	30-015-801	46.11	02-015-801	33.12
00-016-627	16 ROW 20	N/A					
00-016-627	16 ROW 20	AFTER S/N M11650 & BEFORE 8/23/2011	01-001-824	30-018-893	76.18	?	63.11
00-016-627	16 ROW 20	AFTER S/N M11650 & AFTER 8/23/2011	01-001-824	30-018-894	55.96	02-018-898	43.03
00-016-628	18 ROW 20	S/N M11650 & PRIOR	01-001-822	30-018-892	105.94	02-018-899	93.11
00-016-628	18 ROW 20	AFTER S/N M11650	01-001-823	30-018-893	76.18	02-018-900	63.11
00-016-629	6 ROW 30	ALL	01-001-831	30-016-891	40.79	02-016-898	27.80
00-016-630	16 ROW 30	S/N M11650 & PRIOR	01-001-834	30-016-893	160.79	02-016-900	147.76
00-016-630	16 ROW 30	AFTER S/N M11650	01-001-836	30-016-895	130.79	02-016-902	117.76
00-020-0400	RH DR 8 ROW 30	ALL	01-001-831	30-016-891	40.79	02-016-898	27.80
00-020-0401	RH DR 12 ROW 30	S/N M11650 & PRIOR	01-001-832	30-016-892	100.79	02-016-899	87.76

The groups of machines and their telescoping PTO drive connector shaft are listed below:

JD Series 10, 50, 60's either STS or Walker (9550,9610, 9650, 9660, 9760, 9860, etc.) and 20, 00 contour models use 1000 spline.

PART NUMBER *
SUNPS-JD-60 ←

JD Series 20 or 00 (7720, 8820, 9400, 9500, 9600 etc) use special 9600 drive kit (See Photo 037). Kit includes telescoping PTO shaft and chain coupler that couples to sprocket on the feeder housing. Drive kit is mounted at 4 bolt holes on Sunmaster (See Photo 036)..

SUNPS-JD-20

Case-IH Series 1400, 1600, 2100, 2300, etc. use hex spline.

SUNPS-CIH-2388

Case-IH Series 8000 use 540 spline.

SUNPS-CIH-8010

CAT Series use 1000 spline.

SUNPS-CAT

New Holland TR, TX, CR, CX use 540 spline

SUNPS-NH-CR/CX

Gleaner R62, R65, R72, R75, etc. use 1000 spline

SUNPS-GLEANER

* The part numbers in this column are being replaced by the ones on page 43. Effective 1/1/2013

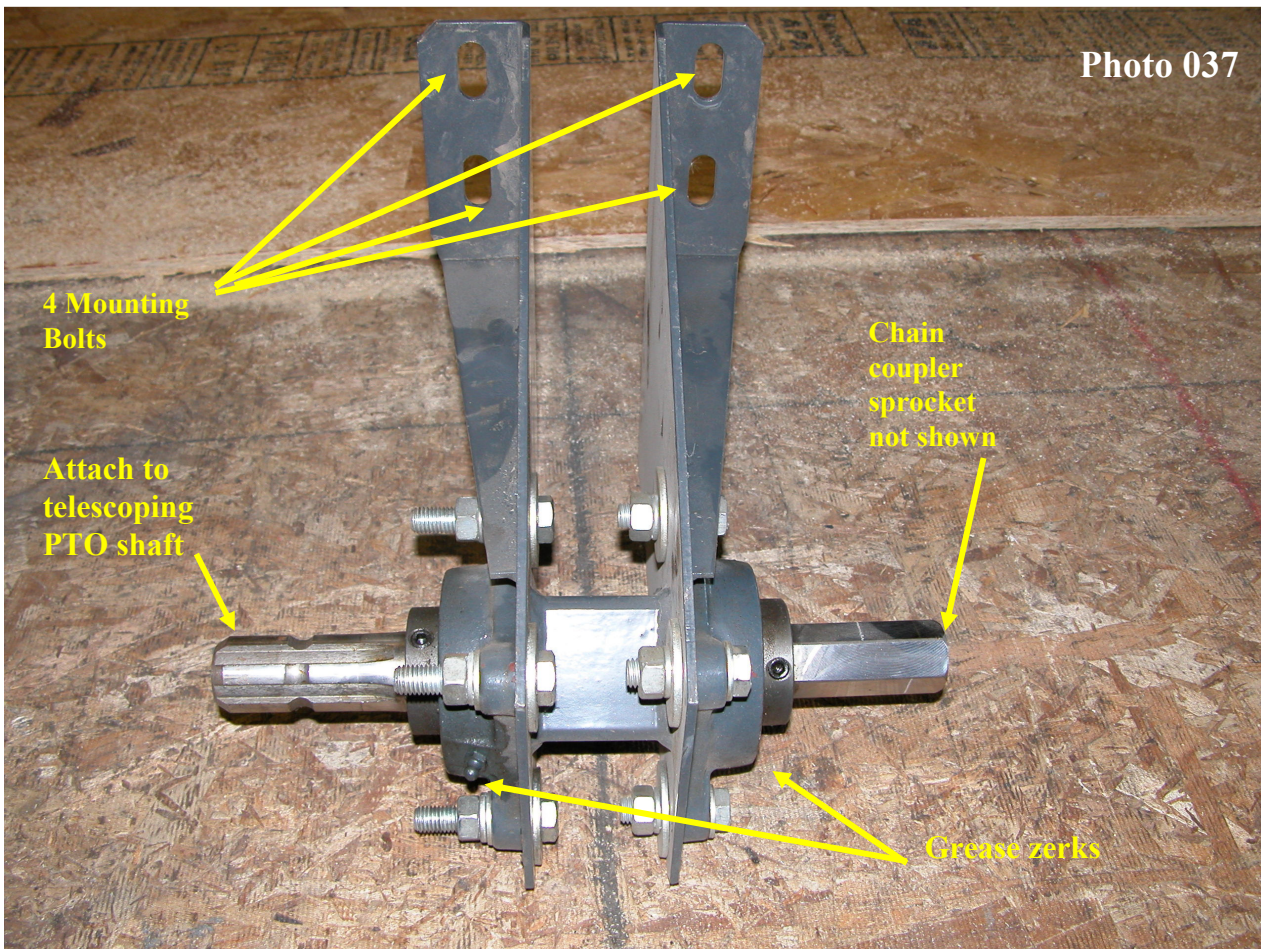

Shipment of units:

All Sunmaster units are shipped with operators manual, parts catalog, special clutch tool, plastic bag containing (2) cutting knives and rivets, and (1) coupler chain for connecting drive shafts to the gearboxes on the underside of the platform. Pieces are stored inside of left side panel for shipment. The unit is also shipped with 3 additional sprockets.

Presettings from the factory:

Many functions of your Sunmaster unit come preset from the factory. Upon startup of your machine please review the following list of preset functions to ensure your machine will operate properly:

1. Uniform vibration of all gathering pans. Maximum recommended vibration is 1/16".
2. Hex nuts are tight for rocker arm height adjustment.
3. Proper gap between rotating knives and stationary knife of 1/32".
4. Proper gathering chain tightness. Measurement is 3 1/2" on tightener or 3/8" max movement of paddle using your finger.
5. Vertical distance of gathering chain above ridge bar is 1/4".
6. Bolts are tight for gathering chain height adjustment.
7. Drum clearance of 1/2 to 3/4" from rib to platform measured at bottom of the concave of platform.
8. Recommended drive sprocket on left side of machine.
9. Recommended driven sprocket on both left and right side of machine.
10. Left side inside panel contains 2 additional sprockets.
11. Right side inside panel contains 1 additional sprocket
12. Left side inside panel contains operators manual, parts book, special clutch tightening tool, (2) extra knives and rivets, (1) coupler chain.
13. Each gearbox filled to within 1/4" below filler plug.
14. Rotary cutting knife clutches each tightened down to 120 ft/lbs.
15. On single drive machines, auger drum clutch tightened to 600 ft/lbs on 8 row machine or 900 ft/lbs. on 12 row machine. For double drive machines 900 ft/lbs. on left side and 500 ft/lbs. on right side.
16. Proper tightness of drive chains on both left and right side of machine.
17. Connecting link on gathering chains pointed in correct direction of travel.
18. Hex nuts are tight on underside of row dividers that adjust downward angle.
19. All zerks have been greased.
20. Adapter is installed and telescoping PTO drive shaft is included.
21. (4) adjustable stands are included.
22. All safety decals are in place.

Lubrication & Maintenance:

The Sunmaster provides trouble free operation with a minimum of maintenance. Refer to the checklist below and photos below for location of grease zerks.

Apply chain lubricant oil to the drive chains inside the left and right side panels every 8 hours.

Check level in gearboxes annually.

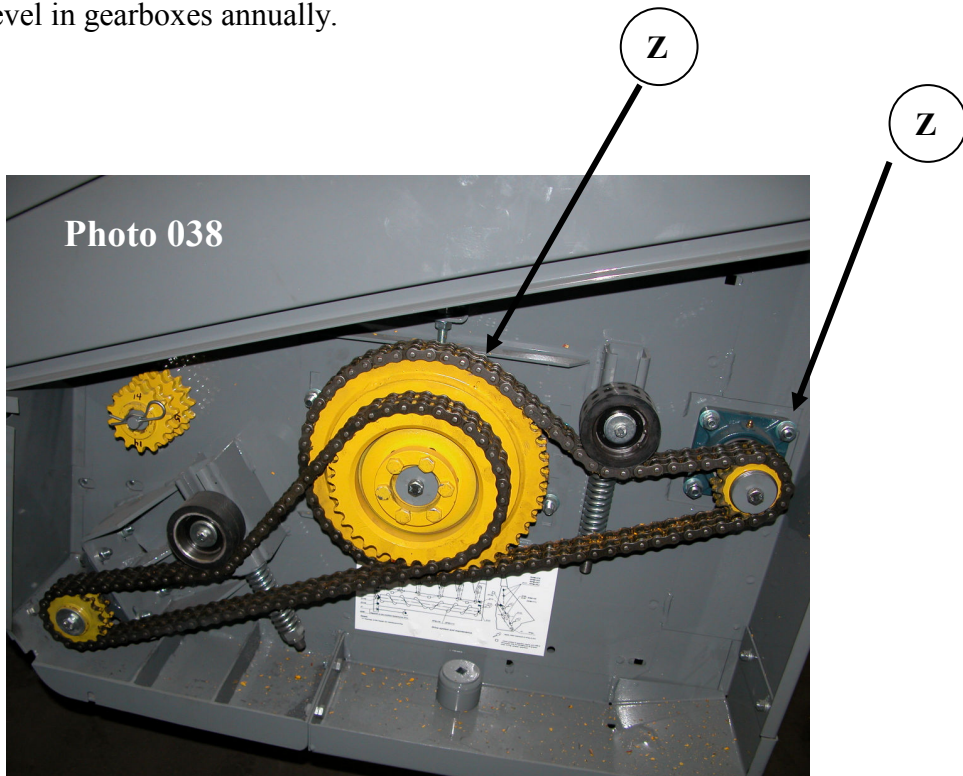

Left Side

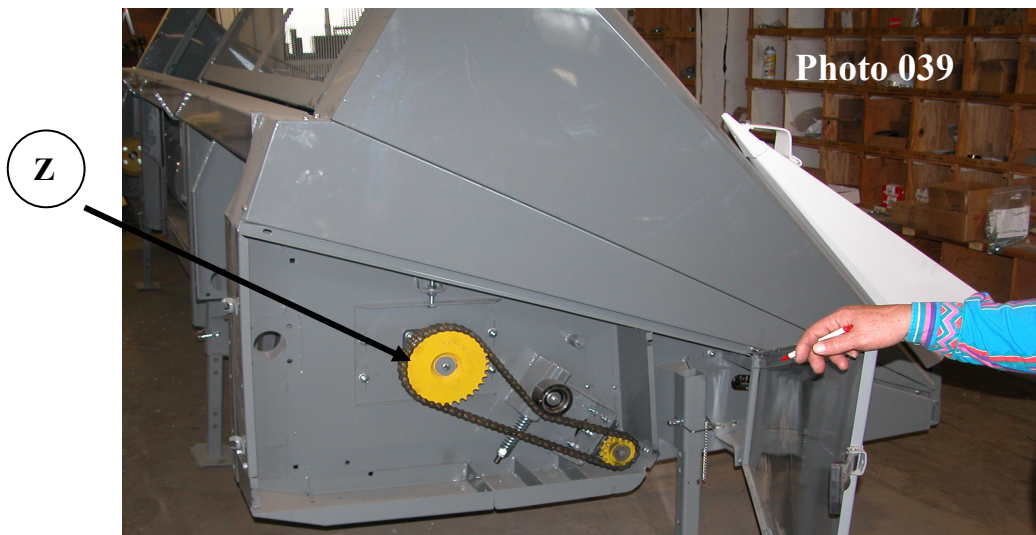

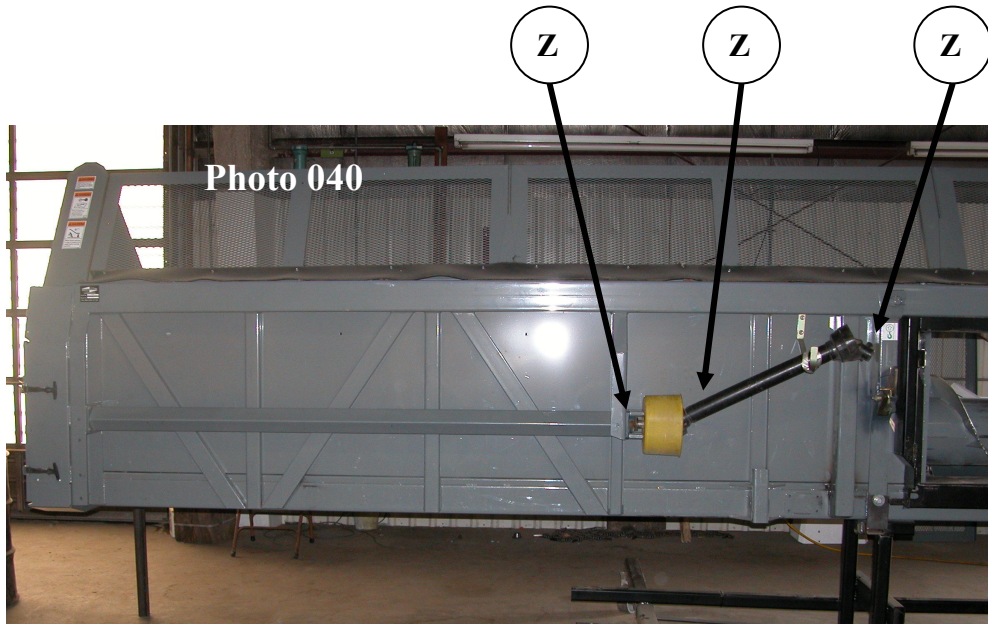

Right Side of Double Drive

INDEX

Part Number	Page
01-001-822	44
01-001-823	44
01-001-824	44
01-001-824	44
01-001-831	44
01-001-831	44
01-001-831	44
01-001-832	44
01-001-832	44
01-001-834	44
01-001-835	44
01-001-836	44
01-015-774	44
02-015-801	44
02-016-898	44
02-016-898	44
02-016-898	44
02-016-899	44
02-016-899	44
02-016-900	44
02-016-901	44
02-016-902	44
02-018-898	44
02-018-899	44
02-018-900	44
100-3-1367	12
24-005-817	18
24-005-825	18
24-005-826	18
24-005-827	18
24-005-828	18
24-005-829	18
24-005-923	18
24-009-241	18
24-009-242	18

Part Number	Page
24-009-243	18
30-015-801	44
30-016-891	44
30-016-891	44
30-016-891	44
30-016-892	44
30-016-892	44
30-016-893	44
30-016-894	44
30-016-895	44
30-018-892	44
30-018-893	44
30-018-893	44
30-018-894	44
69-016-054	10
69-016-055	10
69-016-057	10
69-016-203	11
69-016-204	11
69-016-206	10
69-016-207	10
69-016-208	10
69-016-209	10
69-016-210	10
69-016-211	10
69-016-212	10
69-016-213	10
69-016-214	10
69-016-215	10
69-016-216	10
69-016-217	10
903-18084	43
903-18085	43
903-18085	43
903-18085	43

Part Number	Page
903-18085	43
903-18085	43
903-18086	43
903-18087	43
903-18088	43
903-18088	43
903-18088	43
903-18088	43
903-18088	43
903-18091	43
903-18093	43
903-18094	43
JHE1000	41
JHE1001	41
JHE1002	41
JHE1003	41
JHE1004	41
JHE1005	41
JHE1006	41
JHE1007	41
JHE1008	41
JHE1009	41
JHE1010	41
JHE1011	41
JHE501C	41
JHE505	41
JHE508	41
JHE510	41
JHE511EXT	41
JHE513B	41
JHE525	41
JHE535	41
JHE540	41
JHE545	41
JHE550	41



701 Lenham Ave. - P.O. Box 647

Cooperstown, ND 58425

Office (701) 797-2700

Fax (701) 797-2584

Toll Free (800) 797-1883

www.sheyennemfg.com